

CONTENTS

- SEMICONDUCTOR SHAPES 2-2
- MAIN PARTS LOCATION AND ALIGNMENTS LOCATION 2-3
- WIRING DIAGRAM 2-5
- BLOCK DIAGRAM 2-7
- CIRCUIT DIAGRAMS
 - SIGNAL / FRONT CONTROL / REMO-CON PWB CIRCUIT DIAGRAM 2-11
 - PIP/TEXT PWB CIRCUIT DIAGRAM 2-15
 - AUDIO PWB CIRCUIT DIAGRAM 2-21
 - POWER PWB CIRCUIT DIAGRAM 2-27
 - DEF. PWB CIRCUIT DIAGRAM 2-29
 - CONVERGENCE PWB CIRCUIT DIAGRAM 2-33
 - AV TERMINAL PWB CIRCUIT DIAGRAM 2-35
 - CRT SOCKET PWB CIRCUIT DIAGRAM 2-37
- PATTERN DIAGRAMS
 - SIGNAL PWB PATTERN (SKB-1003A) 2-39
 - PIP/TEXT PWB PATTERN (SKB-0T003A) 2-41
 - AUDIO PWB PATTERN (SKB-6002A) 2-45
 - POWER PWB PATTERN (SKB-9001A) 2-49
 - DEF. PWB PATTERN (SKB-2002A) 2-51
 - CONVERGENCE PWB PATTERN (SKB-8001A) 2-53
 - AV TERMINAL PWB PATTERN (SKB-1202A) 2-55
 - REMO-CON PWB PATTERN (SKB-8102A) 2-56
 - PIN JACK PWB PATTERN (SKB-06101A) 2-56
 - FRONT CONTROL PWB PATTERN (SKB-8101A) 2-56
 - G CRT SOCKET PWB PATTERN (SKB-3001A) 2-57
 - B CRT SOCKET PWB PATTERN (SKB-3002A) 2-58
 - R CRT SOCKET PWB PATTERN (SKB-3003A) 2-58

SEMICONDUCTOR SHAPES

TRANSISTOR

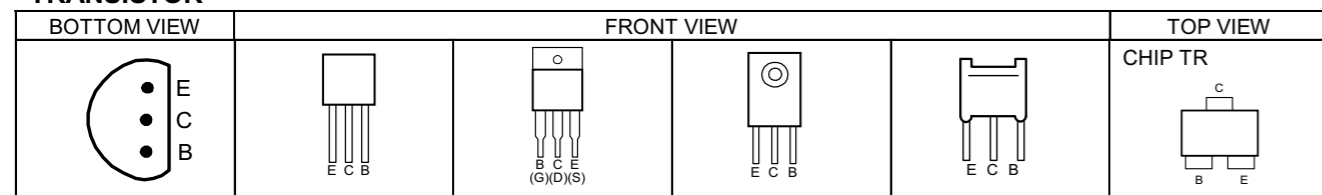

IC

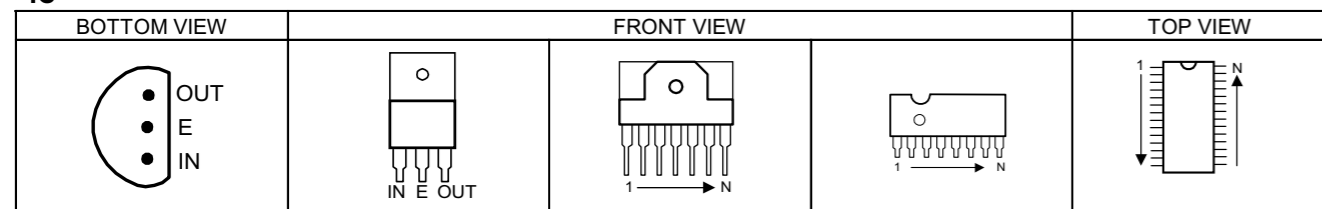

CHIP IC

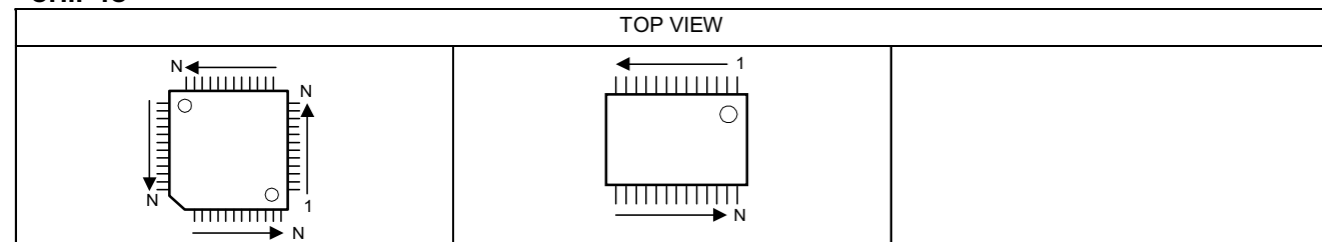

AV-6100/EE STANDARD CIRCUIT DIAGRAM

NOTE ON USING CIRCUIT DIAGRAMS

1. SAFETY

The components identified by the Δ symbol and shading are critical for safety. For continued safety replace safety critical components only with manufactures recommended parts.

2. SPECIFIED VOLTAGE AND WAVEFORM VALUES

The voltage and waveform values have been measured under the following conditions.

- (1) Input signal : Colour bar signal
 - (2) Setting positions of each knob/button and variable resistor : Original setting position when shipped
 - (3) Internal resistance of tester : DC 20k Ω /V
 - (4) Oscilloscope sweeping time : H \Rightarrow 20 μ s/div
: V \Rightarrow 5ms/div
: Others \Rightarrow Sweeping time is specified
 - (5) Voltage values : All DC voltage values
- * Since the voltage values of signal circuit vary to some extent according to adjustments, use them as reference values.

3. INDICATION OF PARTS SYMBOL [EXAMPLE]

● In the PW board : R1209 \rightarrow R209

4. INDICATIONS ON THE CIRCUIT DIAGRAM

(1) Resistors

- Resistance value
 - No unit : [Ω]
 - K : [k Ω]
 - M : [M Ω]
- Rated allowable power
 - No indication : 1/10[W]
 - Others : As specified

● Type

- No indication : Carbon resistor
- OMR : Oxide metal film resistor
- MFR : Metal film resistor
- MPR : Metal plate resistor
- UNFR : Uninflammable resistor
- FR : Fusible resistor

* Composition resistor 1/2 [W] is specified as 1/2S or Comp.

(2) Capacitors

- Capacitance value
 - 1 or higher : [pF]
 - less than 1 : [μ F]
- Withstand voltage
 - No indication : DC50[V]
 - AC indicated : AC withstand voltage [V]
 - Others : DC withstand voltage [V]

* Electrolytic Capacitors
47/50[Example]: Capacitance value [μ F]/withstand voltage[V]

- Type
 - No indication : Ceramic capacitor
 - MY : Mylar capacitor
 - MM : Metalized mylar capacitor
 - PP : Polypropylene capacitor
 - MPP : Metalized polypropylene capacitor
 - MF : Metalized film capacitor
 - TF : Thin film capacitor
 - BP : Bipolar electrolytic capacitor
 - TAN : Tantalum capacitor

(3) Coils

- No unit : [μ H]
- Others : As specified

(4) Power Supply

- : B1 (130V)
- : 12V (12V)
- : 9V
- : 5V

* Respective voltage values are indicated

(5) Test point

- : Test point
- : Only test point display

(6) Connecting method

- : Connector
- : Wrapping or soldering
- : Receptacle

(7) Ground symbol

- : LIVE side ground
- : ISOLATED(NEUTRAL) side ground
- : EARTH ground
- : DIGITAL ground

5. NOTE FOR REPAIRING SERVICE

This model's power circuit is partly different in the GND. The difference of the GND is shown by the LIVE (\perp) side GND and the ISOLATED(NEUTRAL) (\neq) side GND. Therefore, care must be taken for the following points.

- (1) Do not touch the LIVE side GND or the LIVE side GND and the ISOLATED(NEUTRAL) side GND simultaneously. If the above caution is not respected, an electric shock may be caused. Therefore, make sure that the power cord is surely removed from the receptacle when, for example, the chassis is pulled out.
- (2) Do not short between the LIVE side GND and ISOLATED(NEUTRAL) side GND or never measure with a measuring apparatus (oscilloscope, etc.) the LIVE side GND and ISOLATED(NEUTRAL) side GND at the same time. If the above precaution is not respected, a fuse or any parts will be broken.

◇ Since the circuit diagram is a standard one, the circuit and circuit constants may be subject to change for improvement without any notice.

MAIN PARTS LOCATION AND ALIGNMENTS LOCATION

CONVERGENCE PWB VRs LOCATION

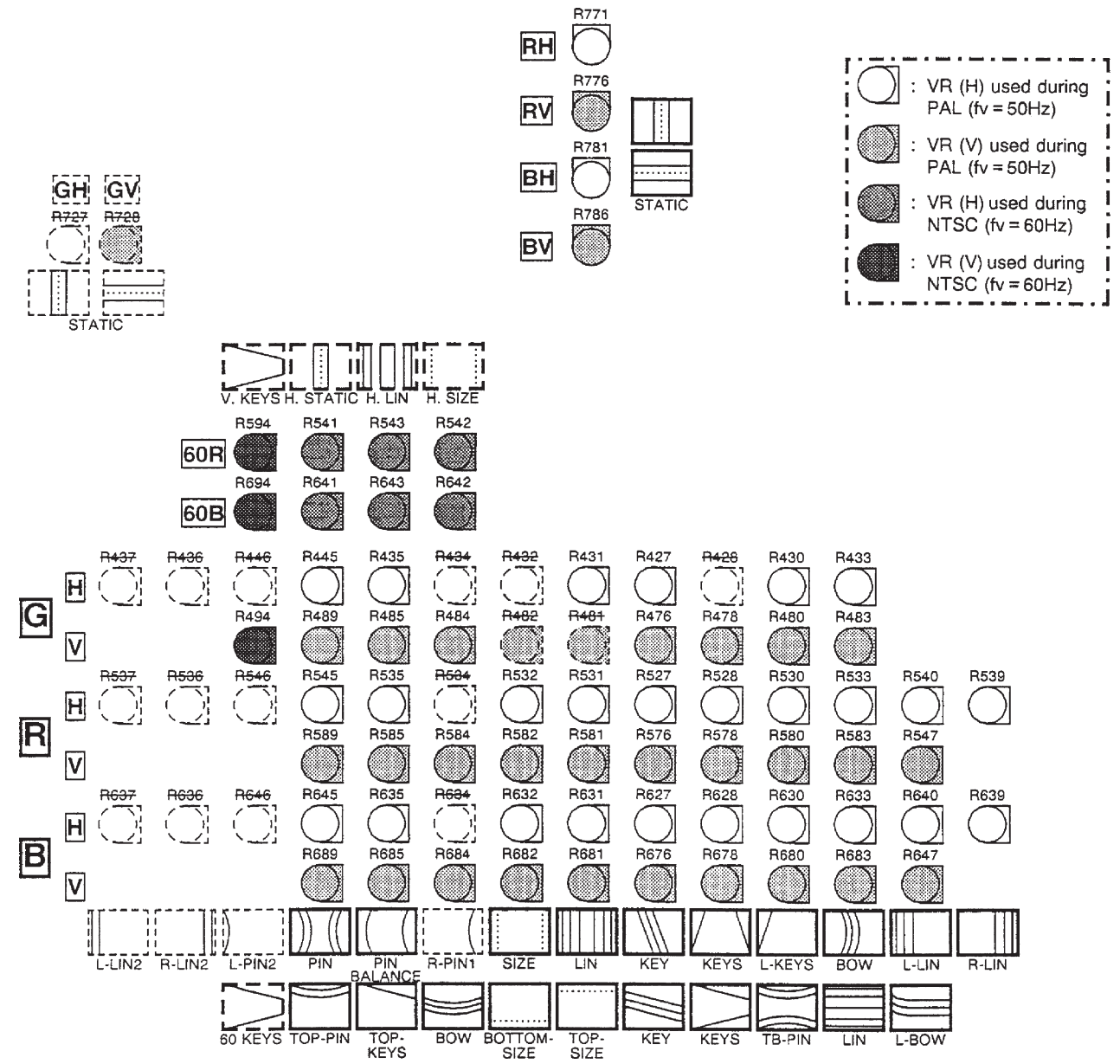
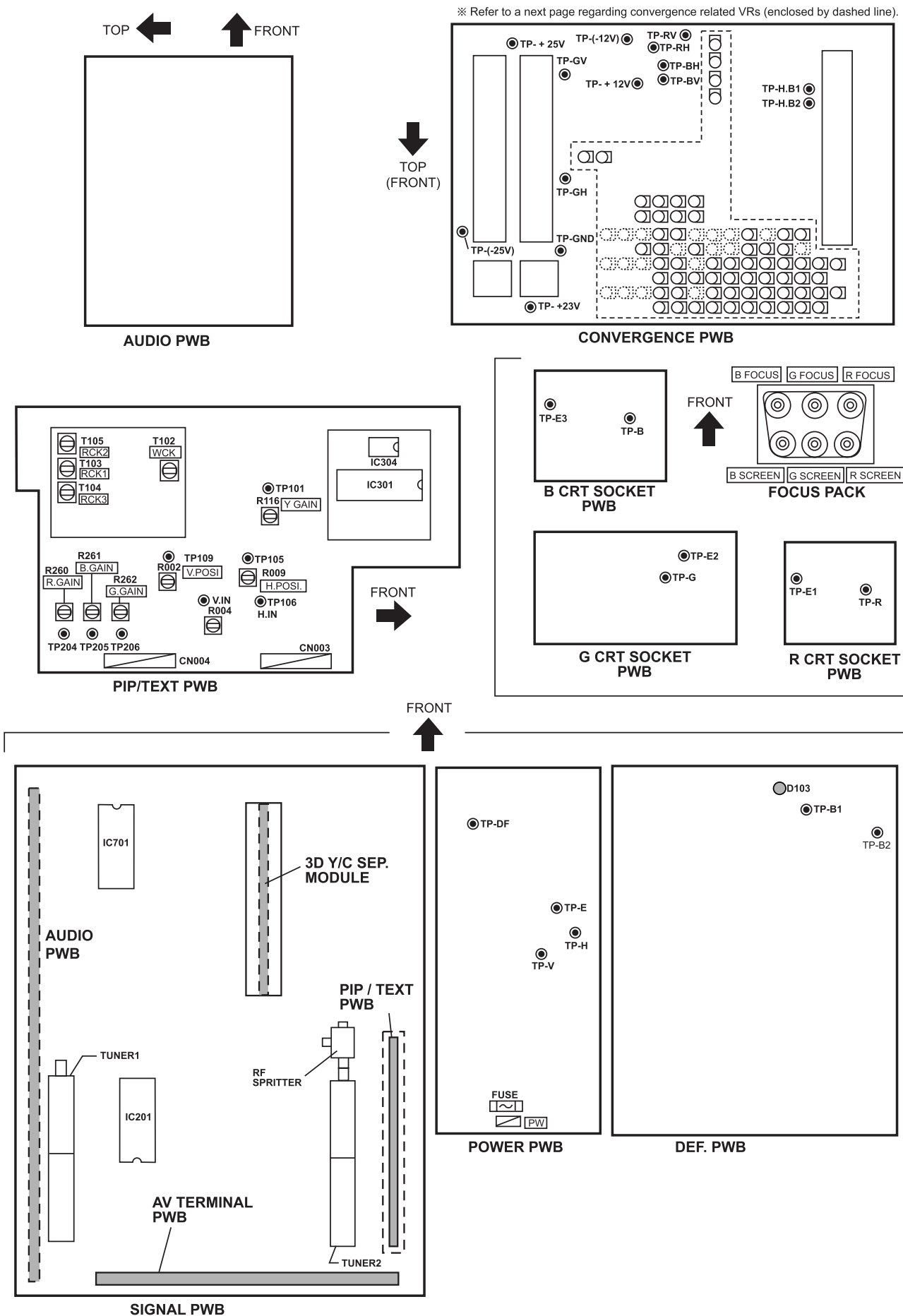

WIRING DIAGRAM

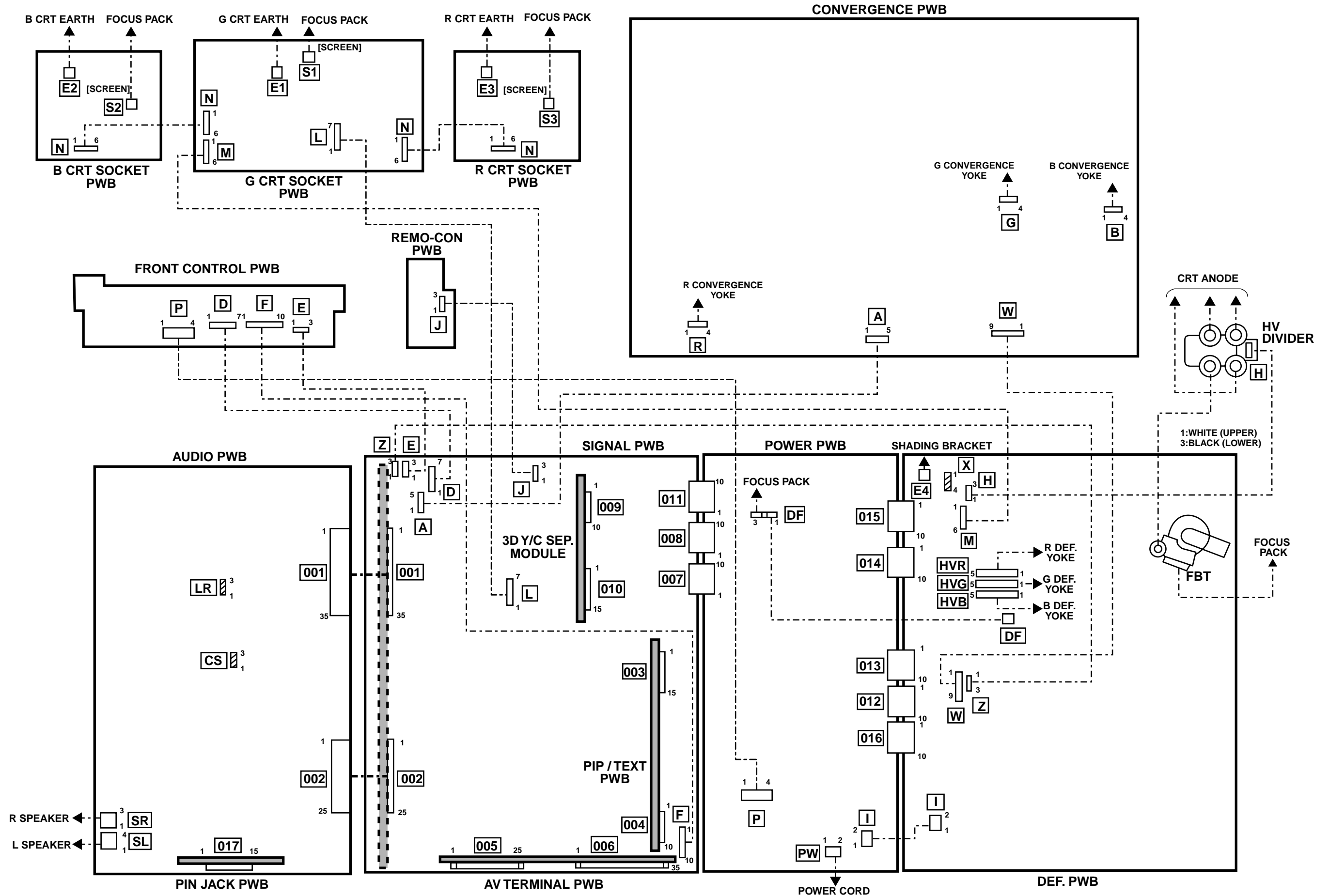

3D Y/C SEP. MODULE BLOCK DIAGRAM

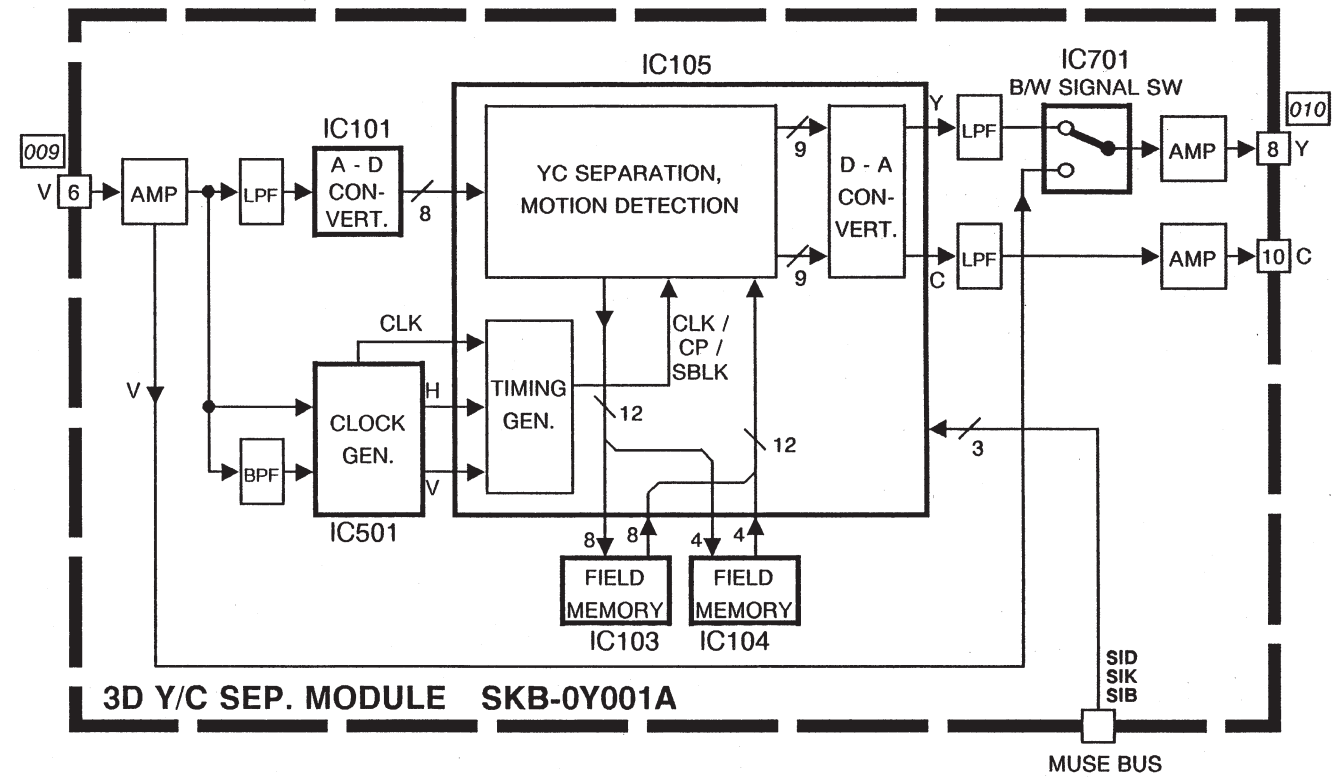

SIGNAL PWB CIRCUIT WAVEFORMS

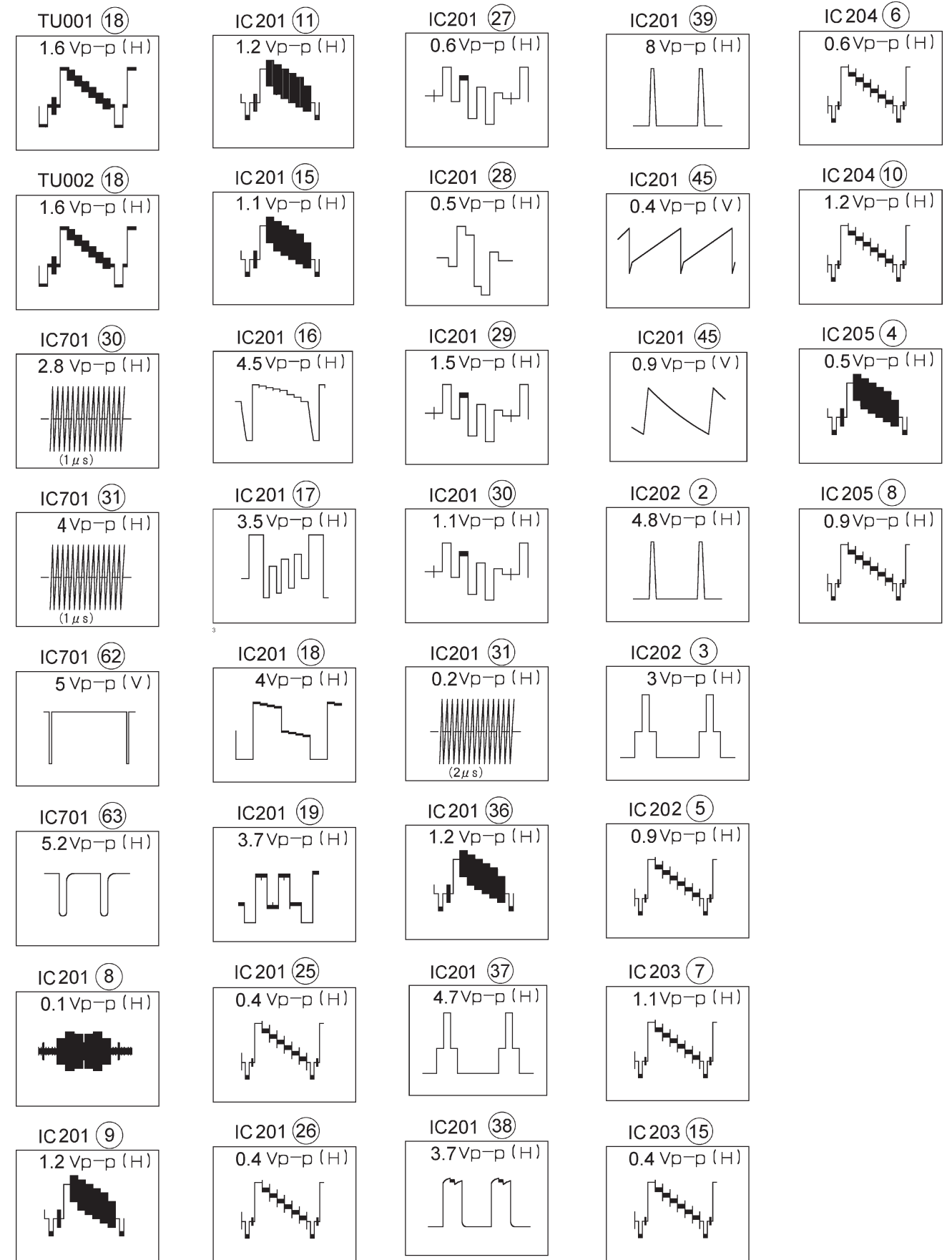

CIRCUIT DIAGRAMS

SIGNAL / FRONT CONTROL / REMO-CON PWB CIRCUIT DIAGRAMS - 1/2

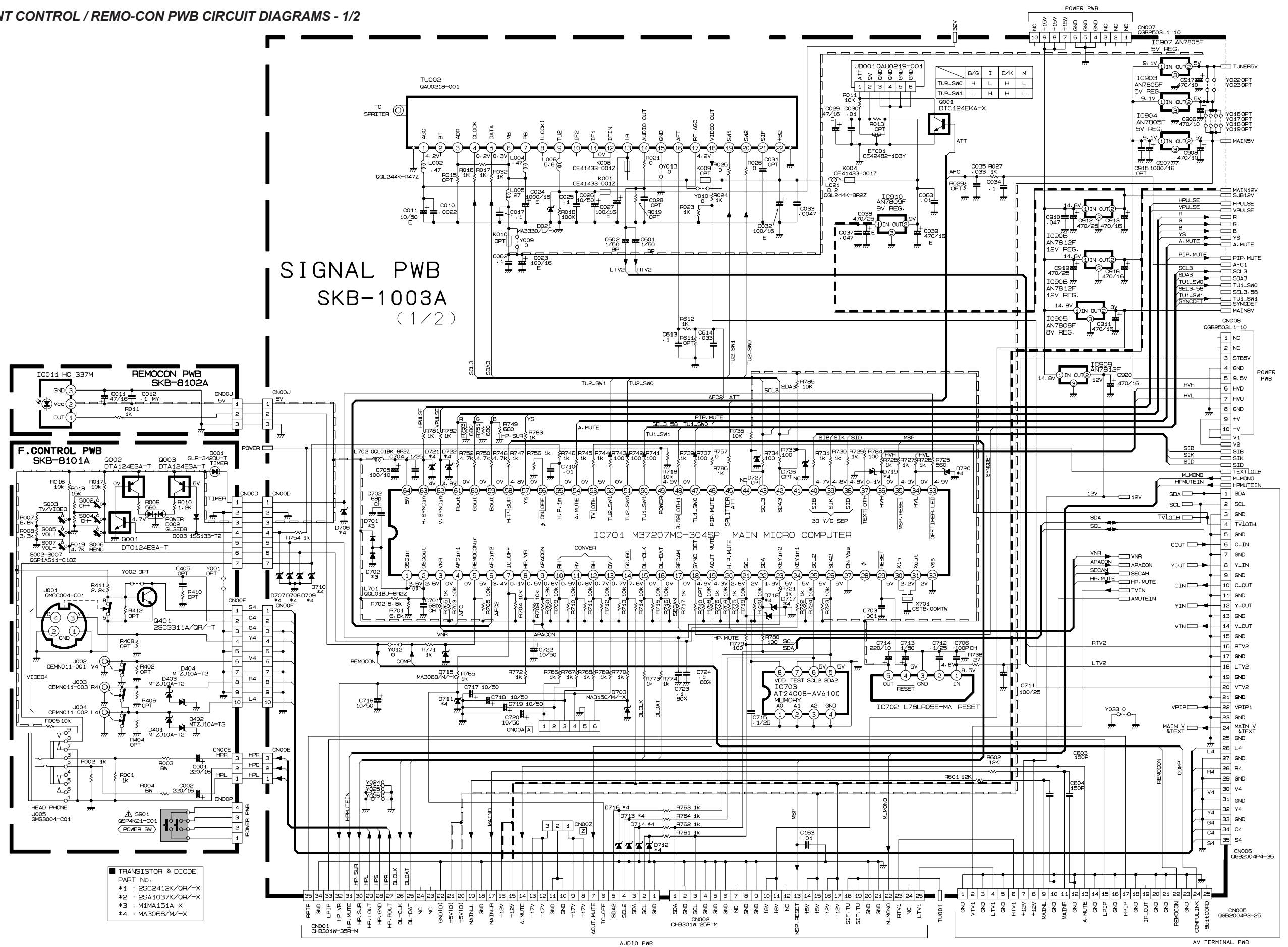

SIGNAL / FRONT CONTROL / REMO-CON PWB CIRCUIT DIAGRAMS - 2/2

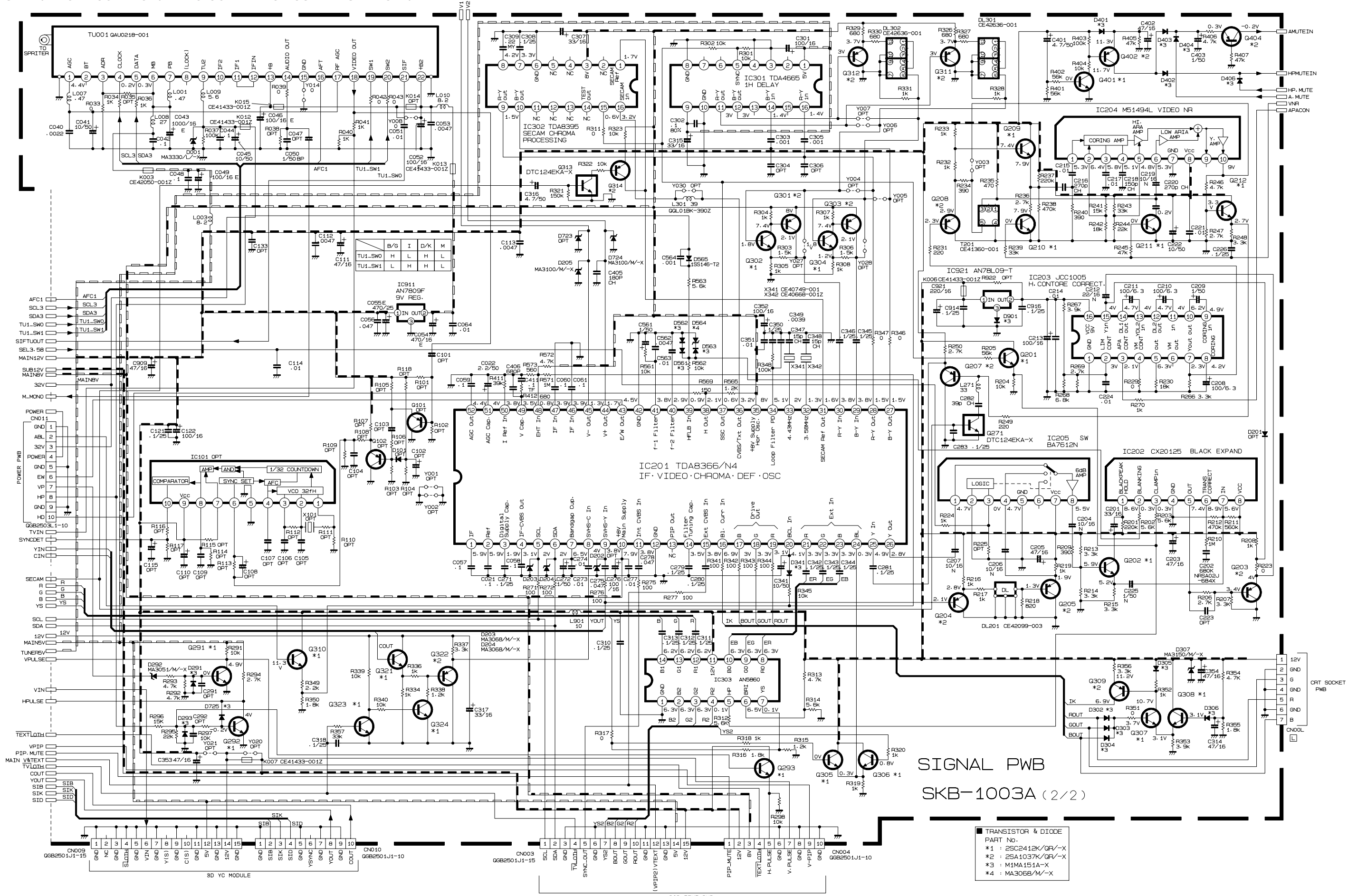

SIGNAL PWB
SKB-1003A (2/2)

- TRANSISTOR & DIODE PART NO.
- *1 : 2SC2412K/QR/-X
 - *2 : 2SA1037K/QR/-X
 - *3 : M1MA151A-X
 - *4 : MA3068M/-X

PIP/TEXT PWB CIRCUIT DIAGRAMS - 1/3

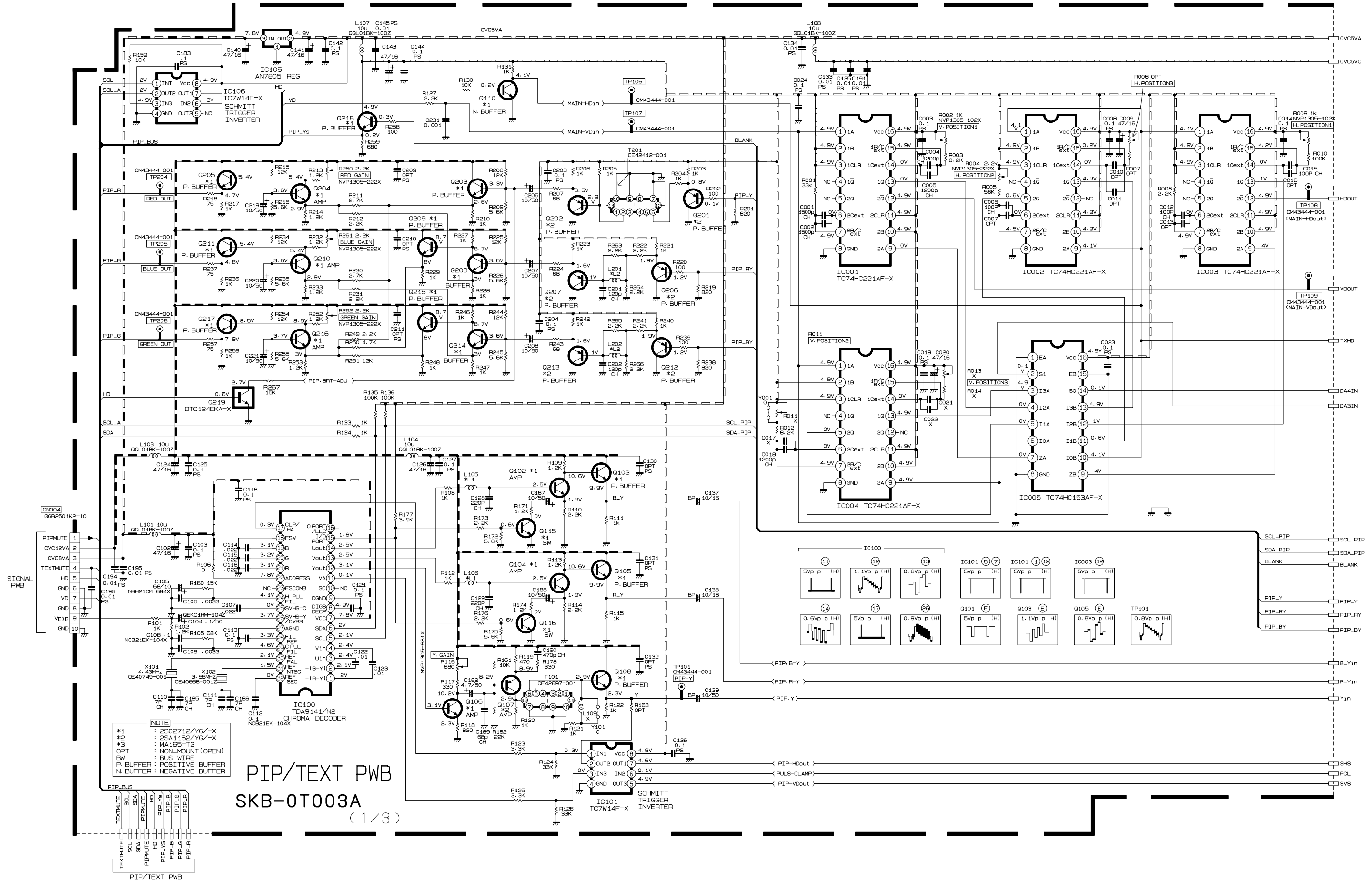

PIP/TEXT PWB SKB-0T003A (1/3)

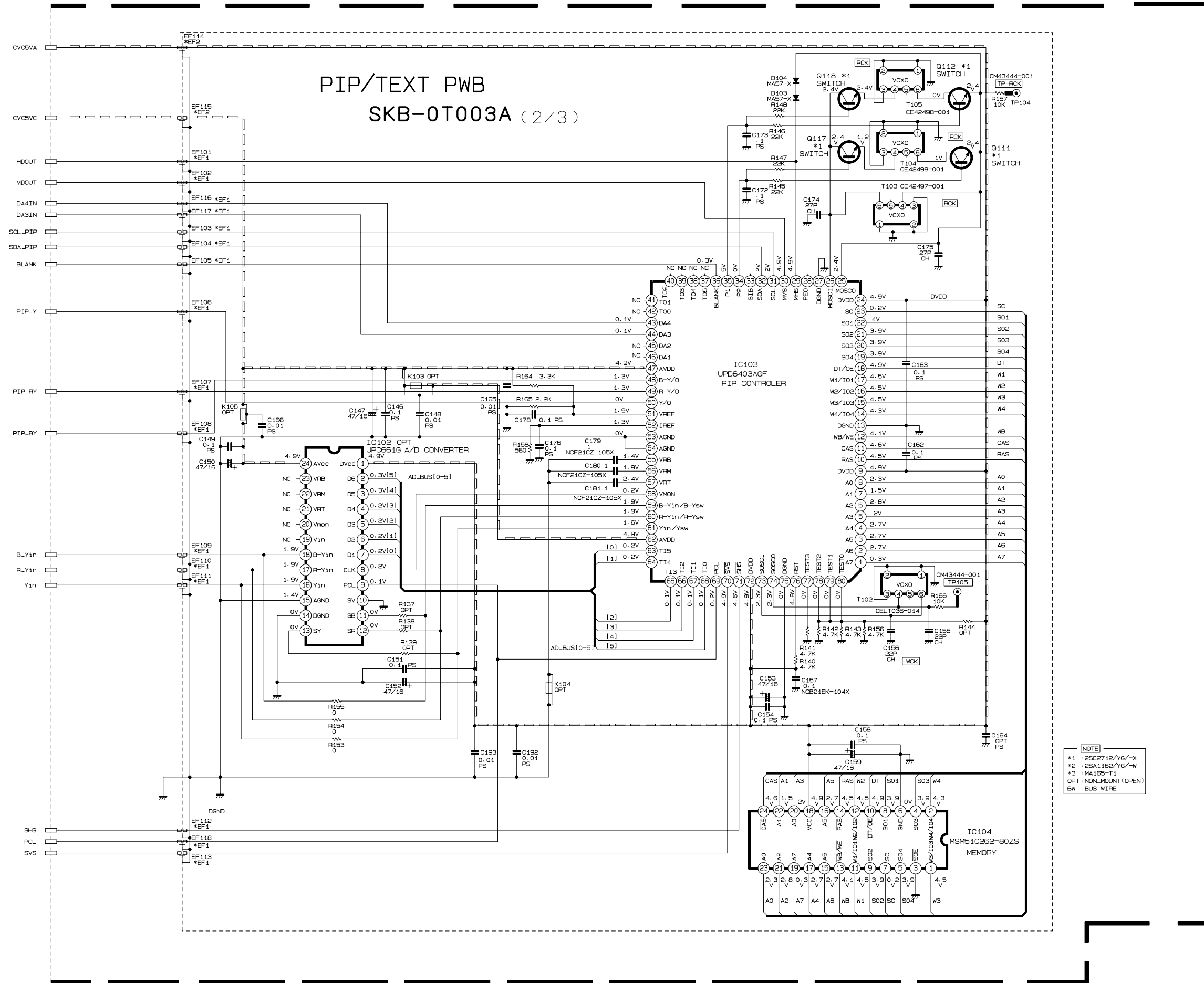

PIP/TEXT PWB

SKB-0T003A

(3/3)

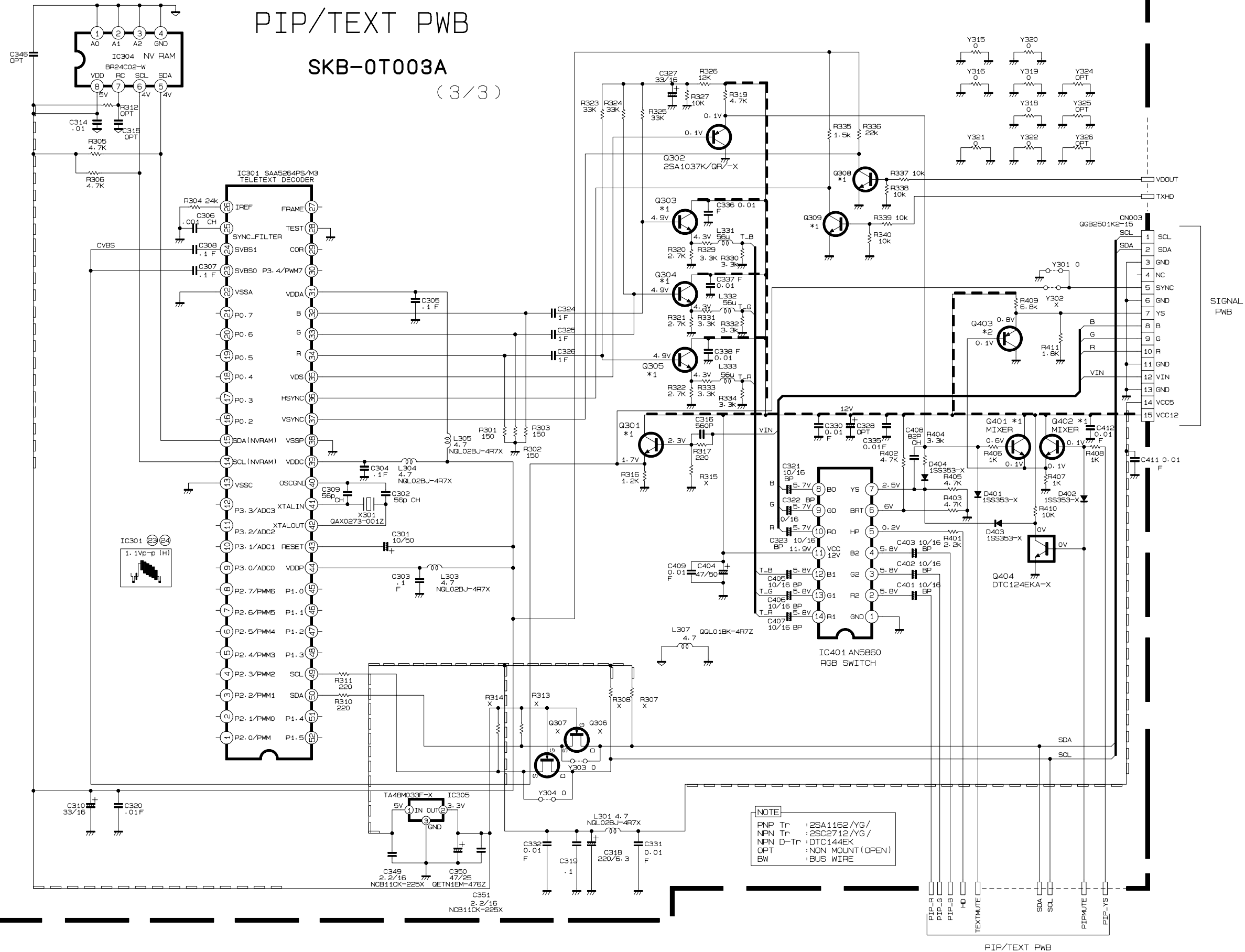

AUDIO PWB CIRCUIT DIAGRAMS - 1/3

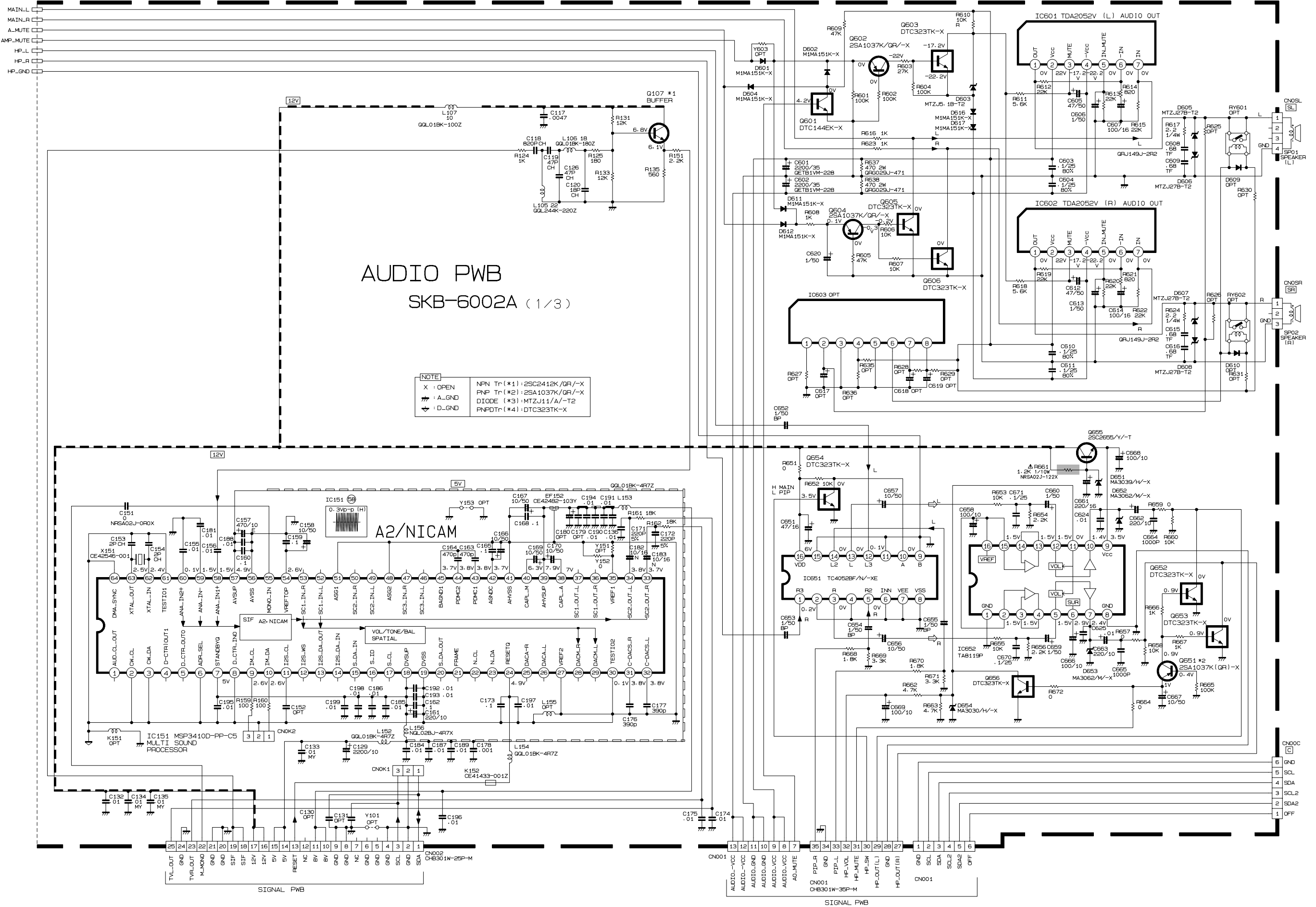

AUDIO PWB CIRCUIT DIAGRAMS -3/3

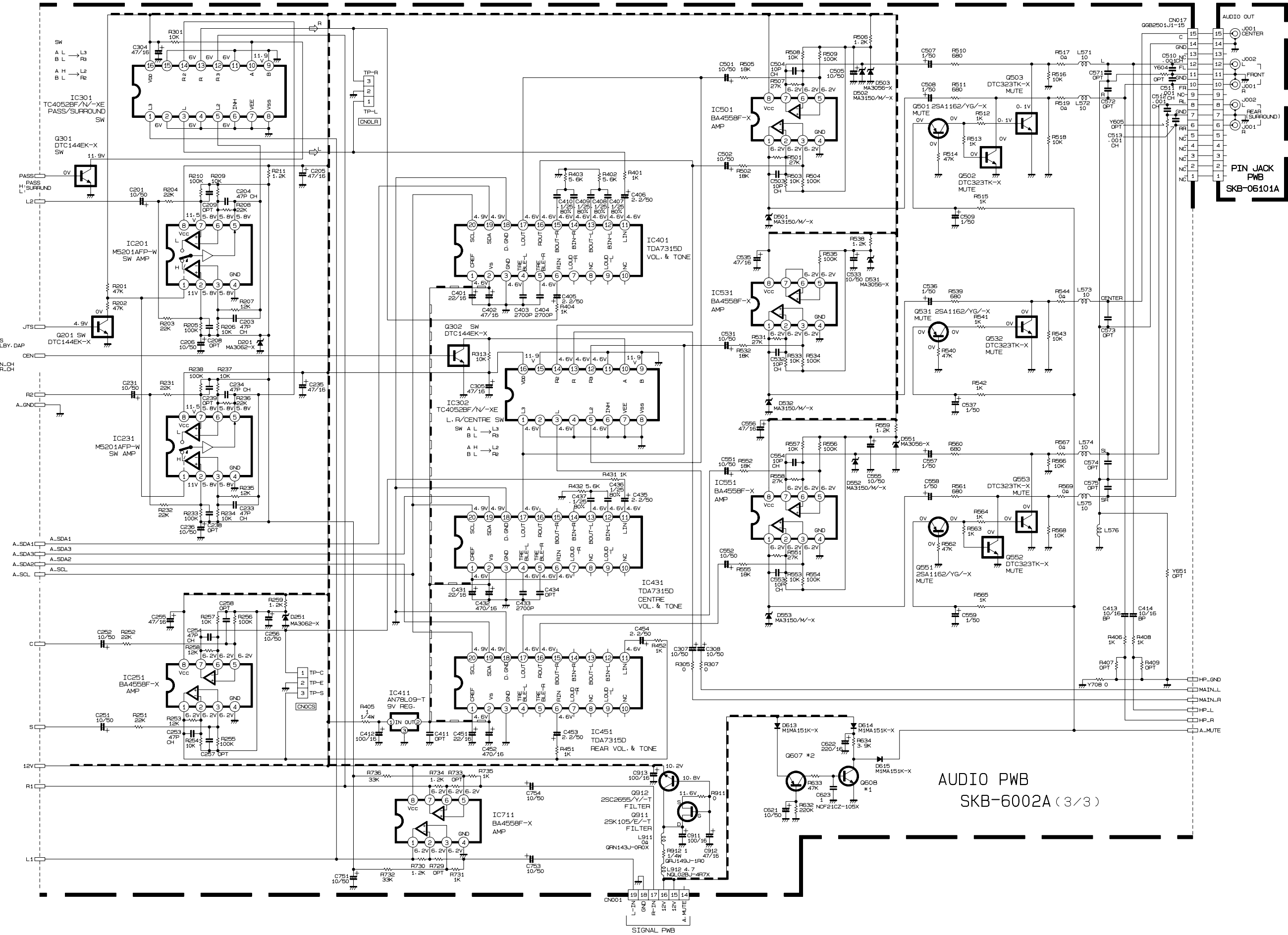

POWER PWB CIRCUIT DIAGRAM

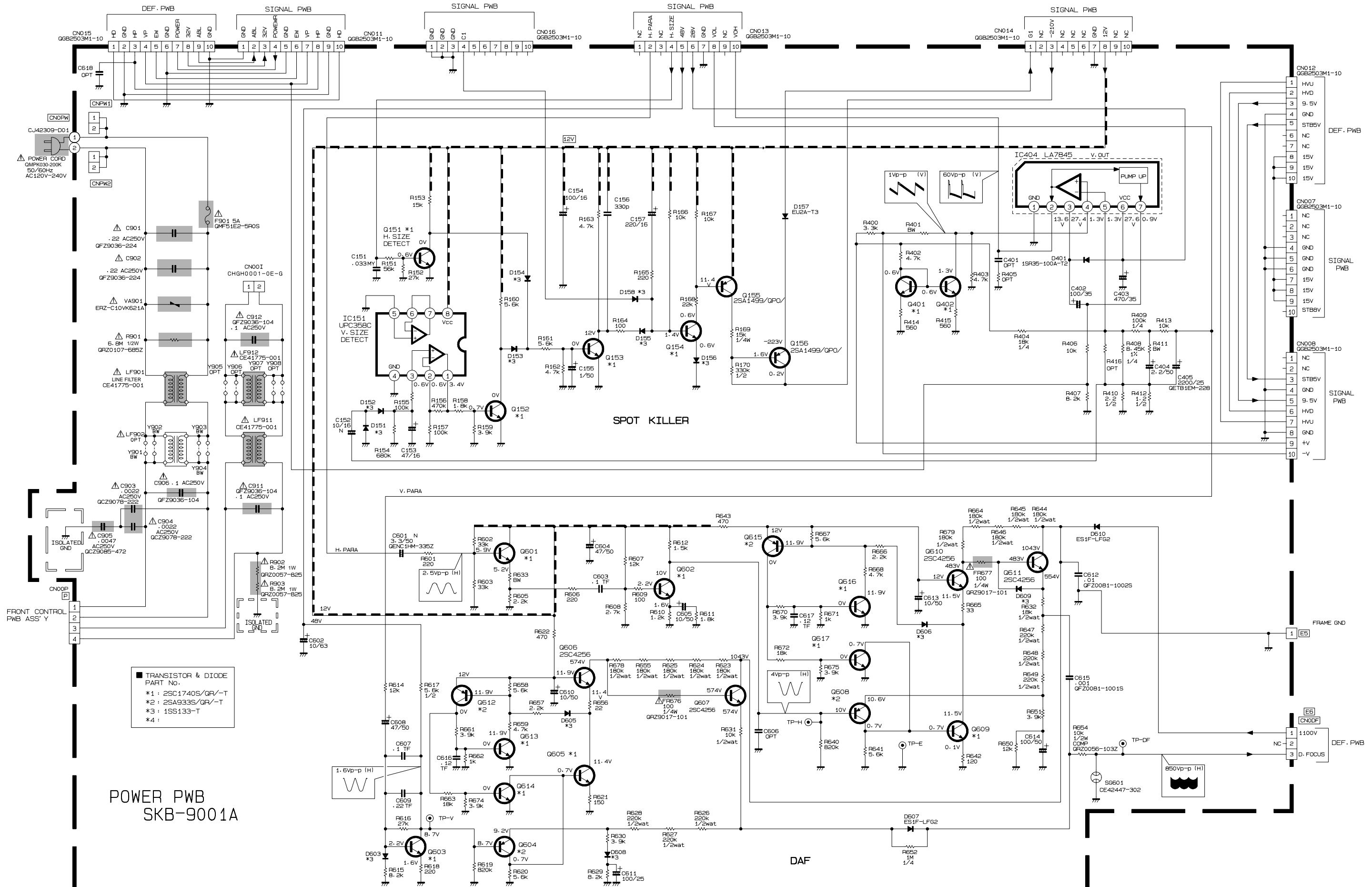

POWER PWB
SKB-9001A

- TRANSISTOR & DIODE
PART NO.
- *1 : 2SC1740S/QR/-T
 - *2 : 2SA933S/QR/-T
 - *3 : 1SS133-T
 - *4 :

DEF. PWB CIRCUIT DIAGRAMS -2/2

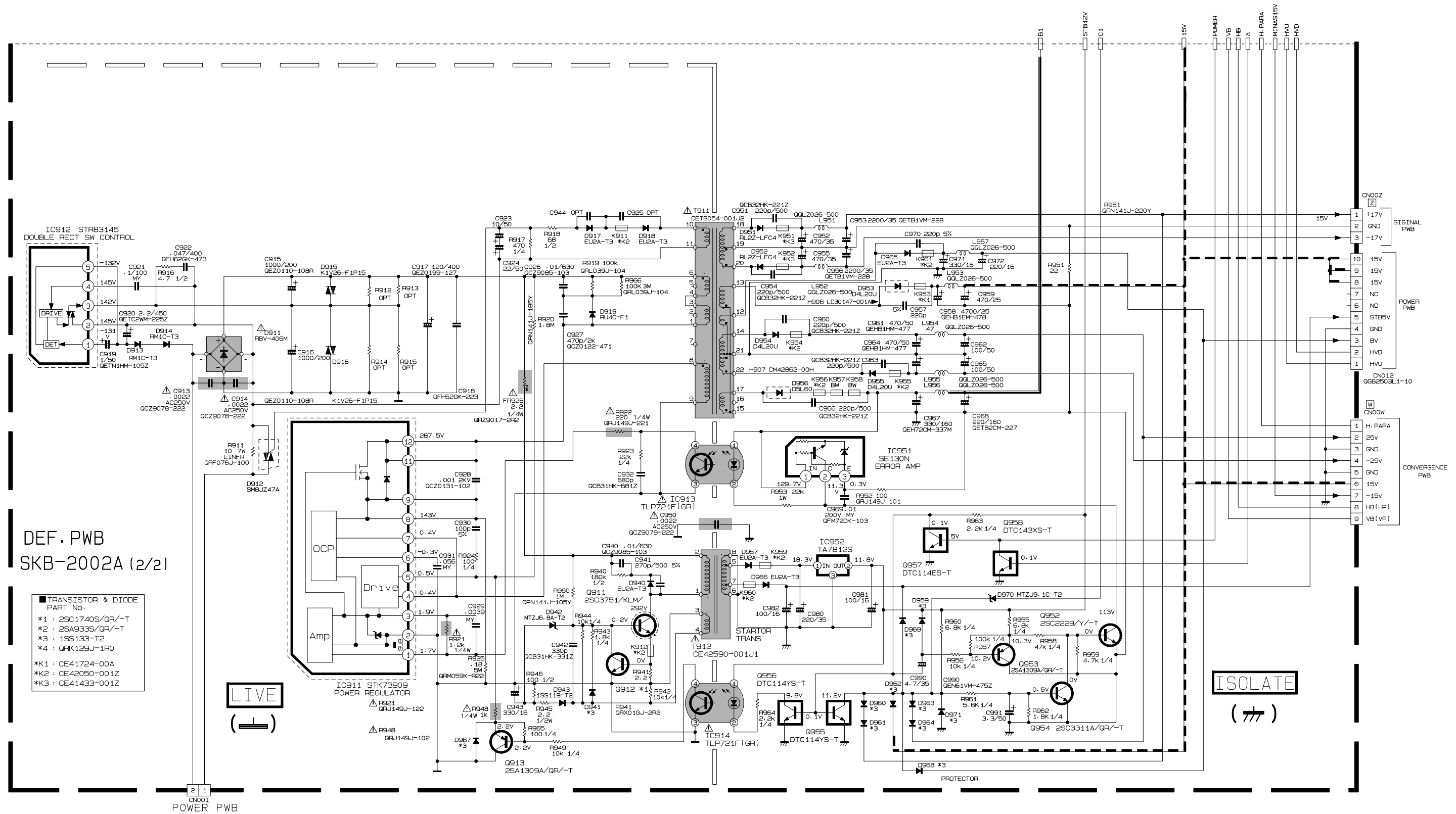

CONVERGENCE PWB CIRCUIT DIAGRAM

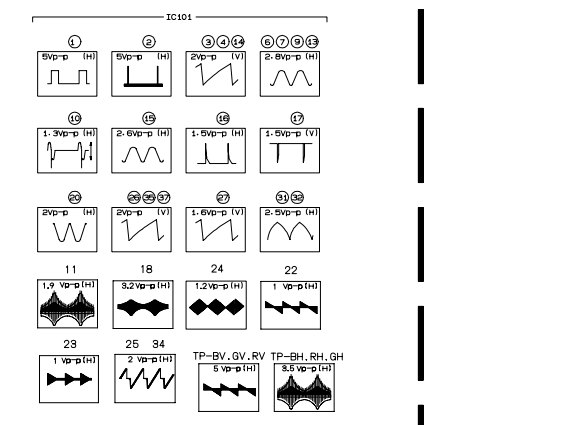
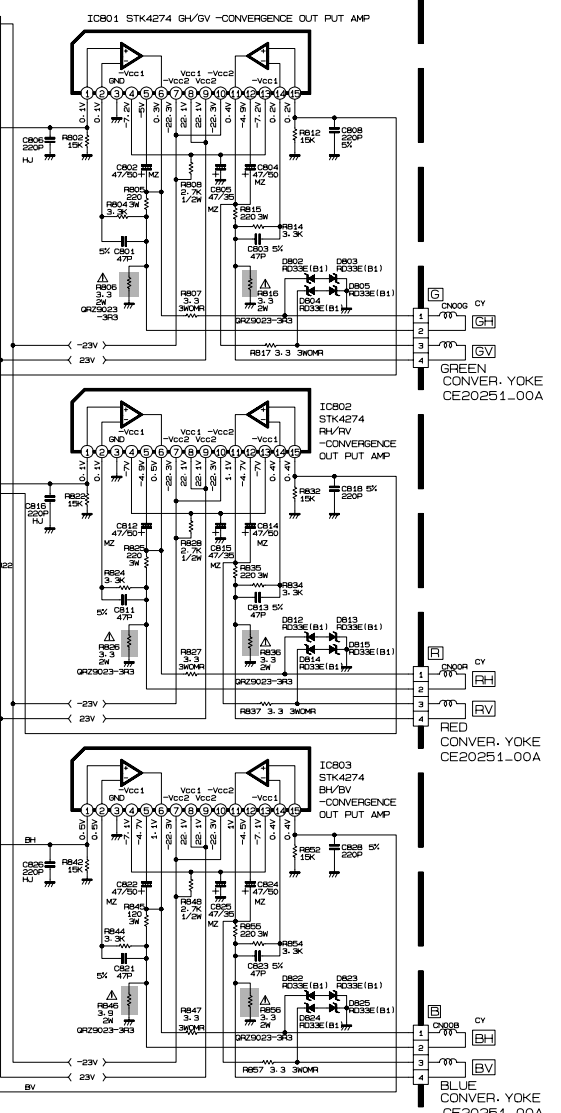
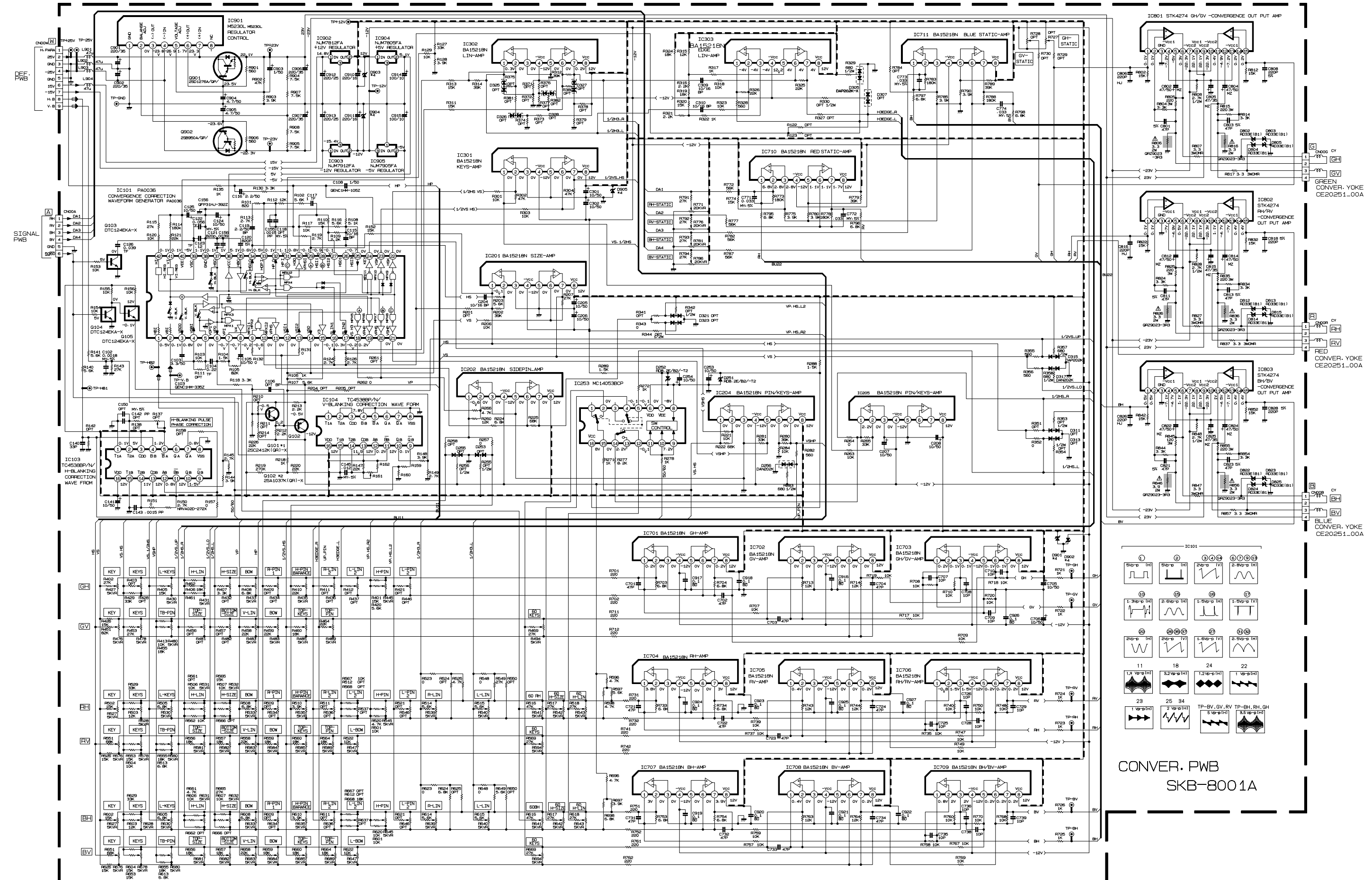

CONVER. PWB SKB-8001A

AV TERMINAL PWB CIRCUIT DIAGRAM

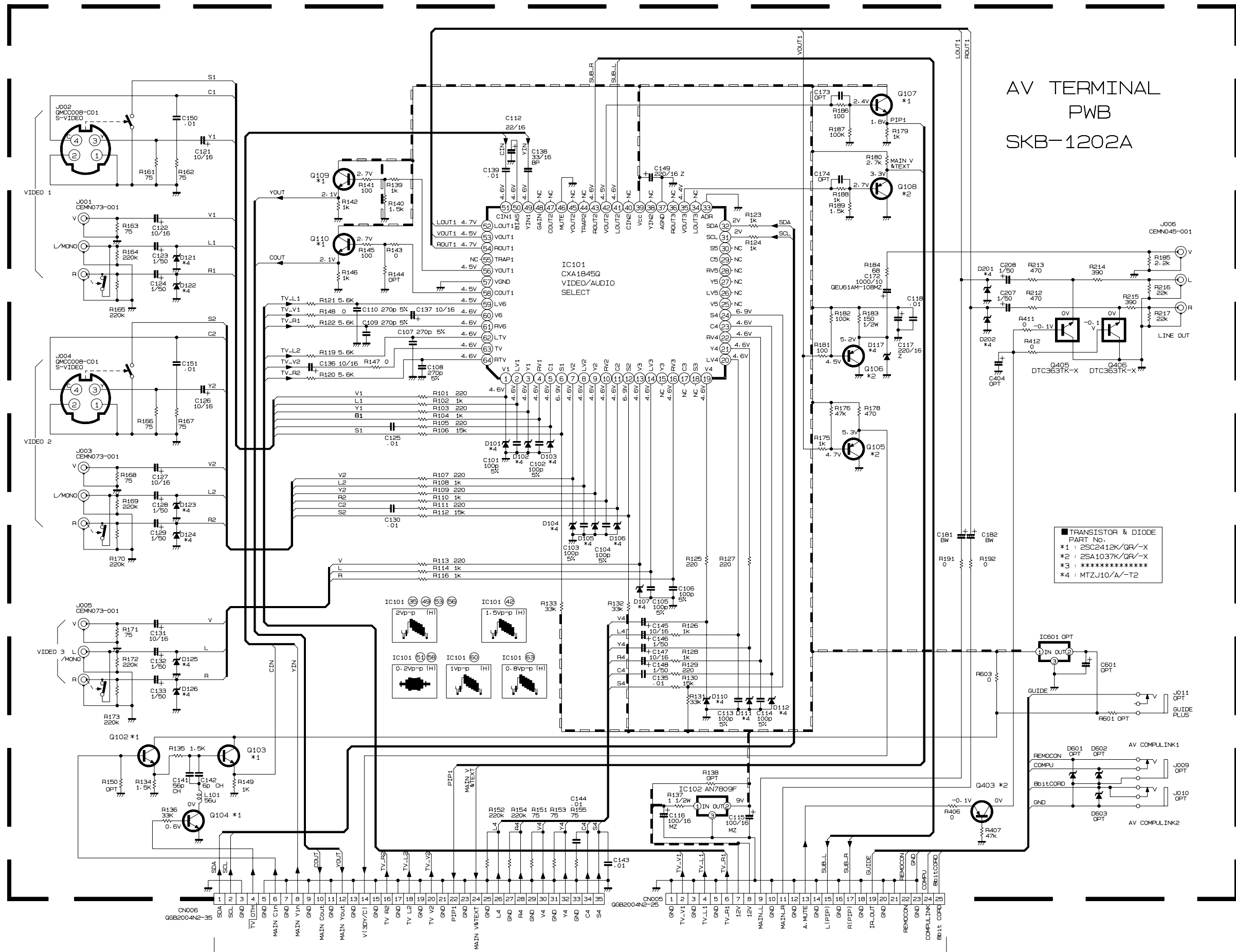

AV TERMINAL PWB SKB-1202A

CRT SOCKET PWB CIRCUIT DIAGRAM

TRANSISTOR & DIODE
PART No.

- *1 : 2SC2412K/QR/-X
- *2 : 2SA1037K/QR/-X
- *3 : 1SS133-T2
- *4 : 2SC4544-C1
- *5 : 2SC4502-T

CRT SOCKET PWB
SKB-3001A/SKB-3002A/SKB-3003A

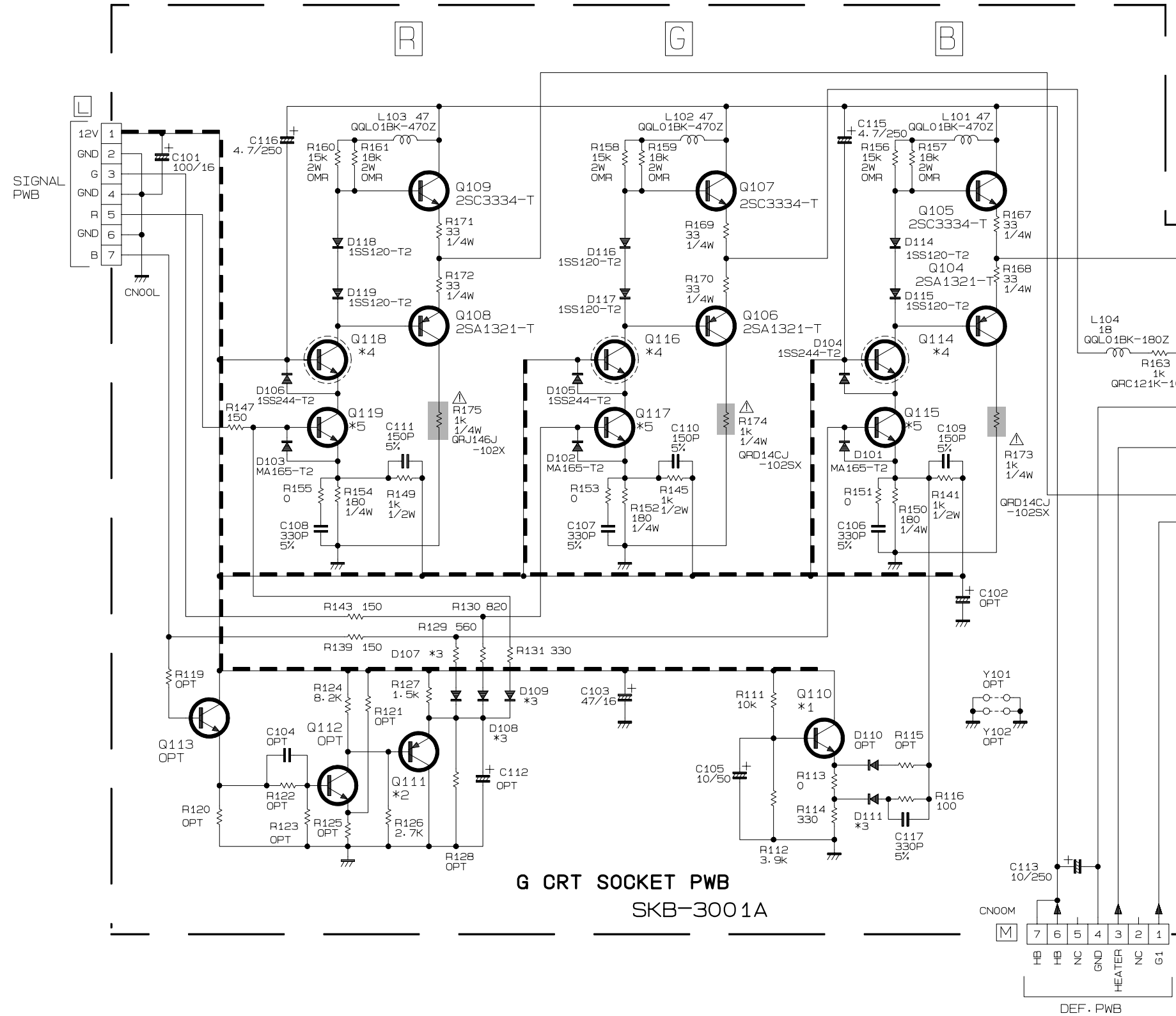

G CRT SOCKET PWB
SKB-3001A

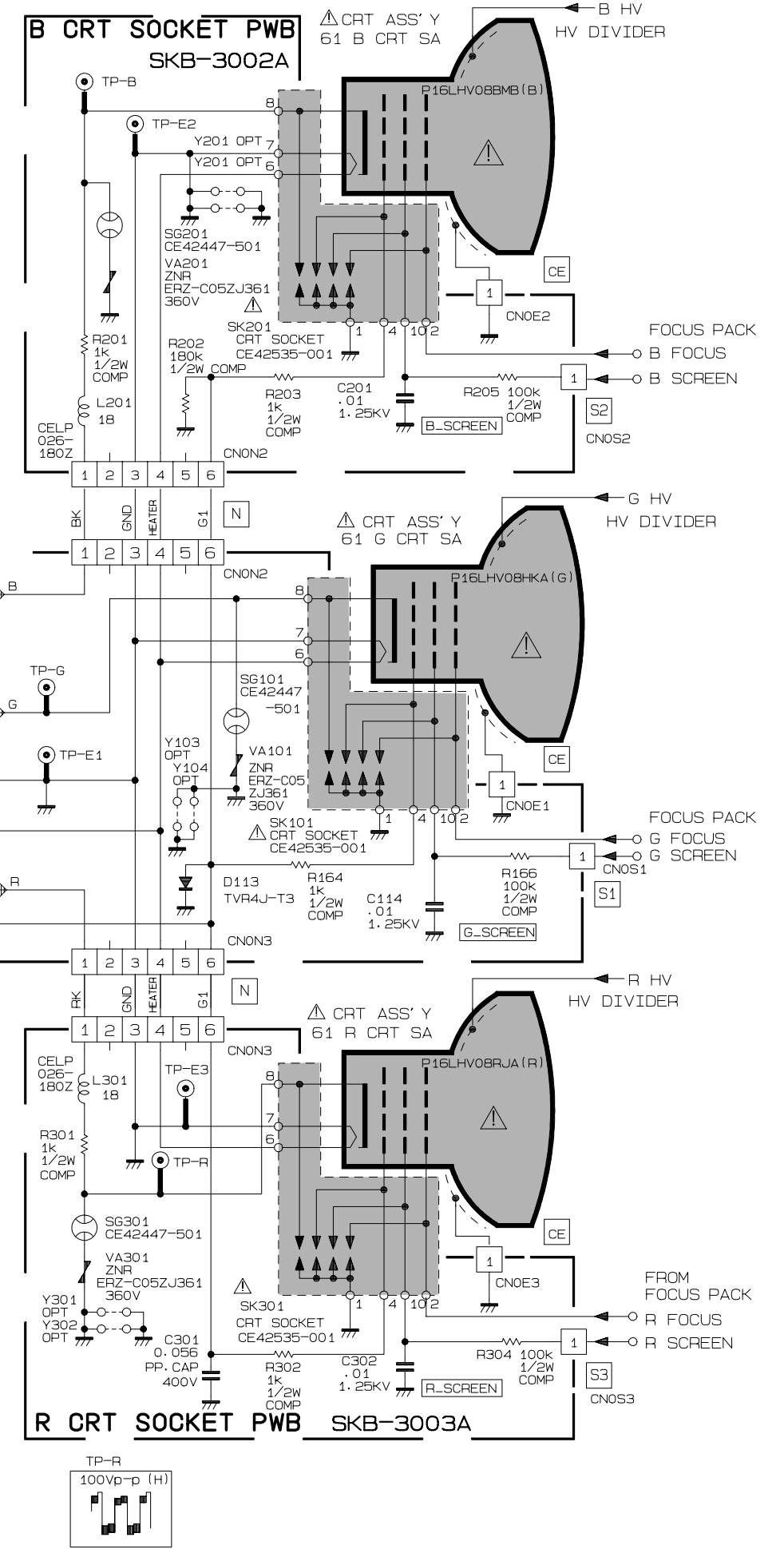

R CRT SOCKET PWB
SKB-3003A

PATTERN DIAGRAMS SIGNAL PWB PATTERN

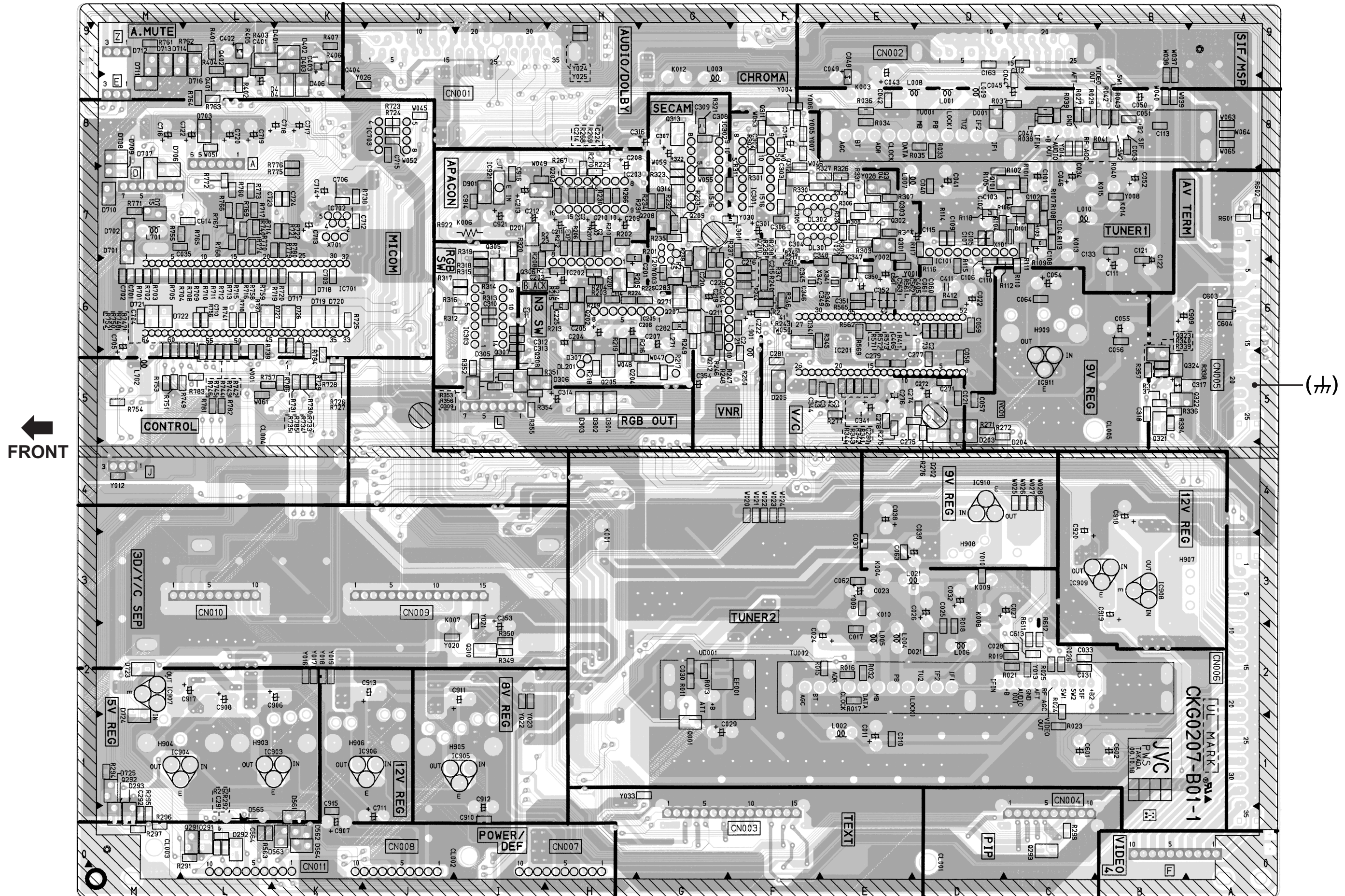

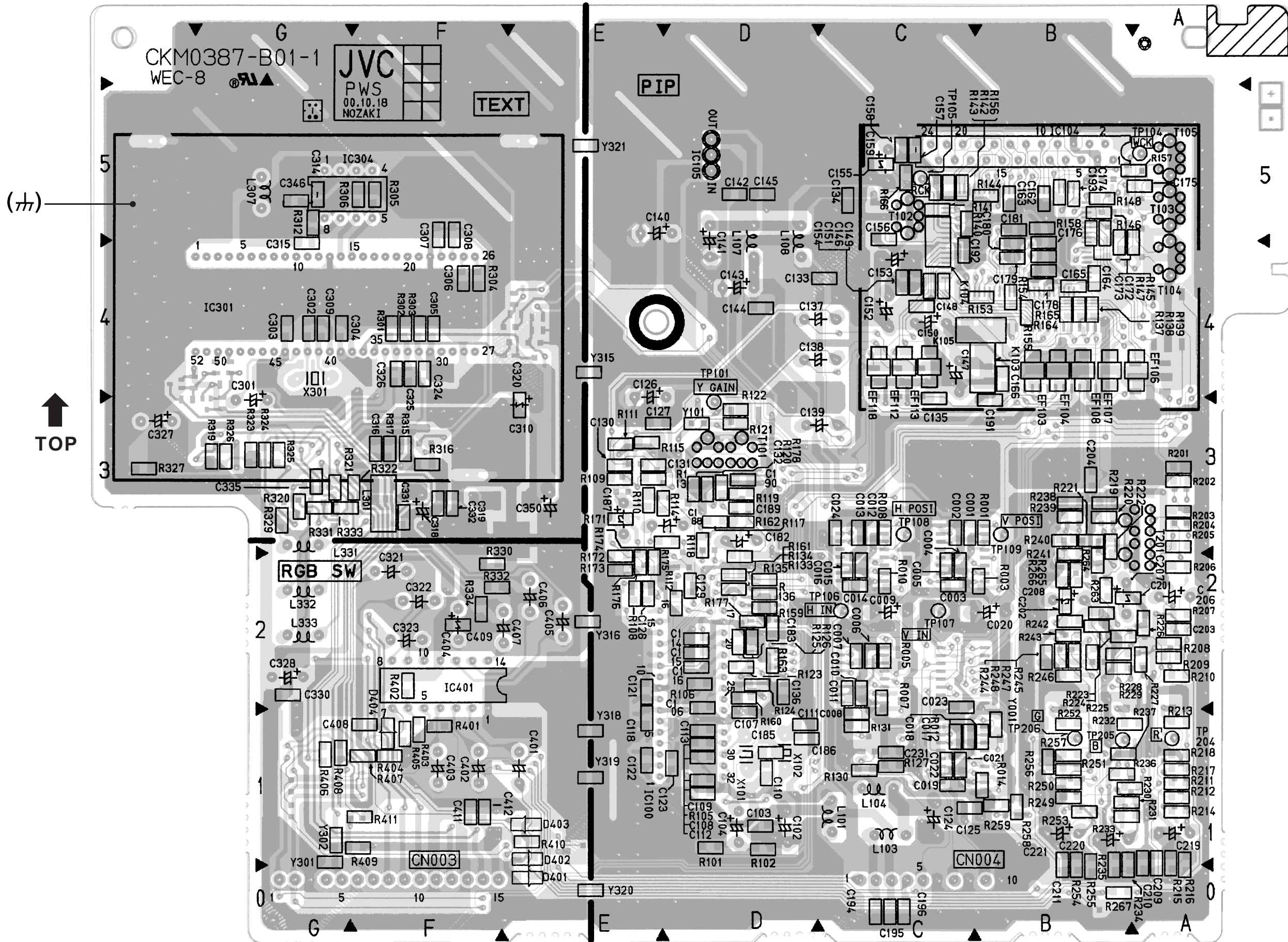

FRONT →

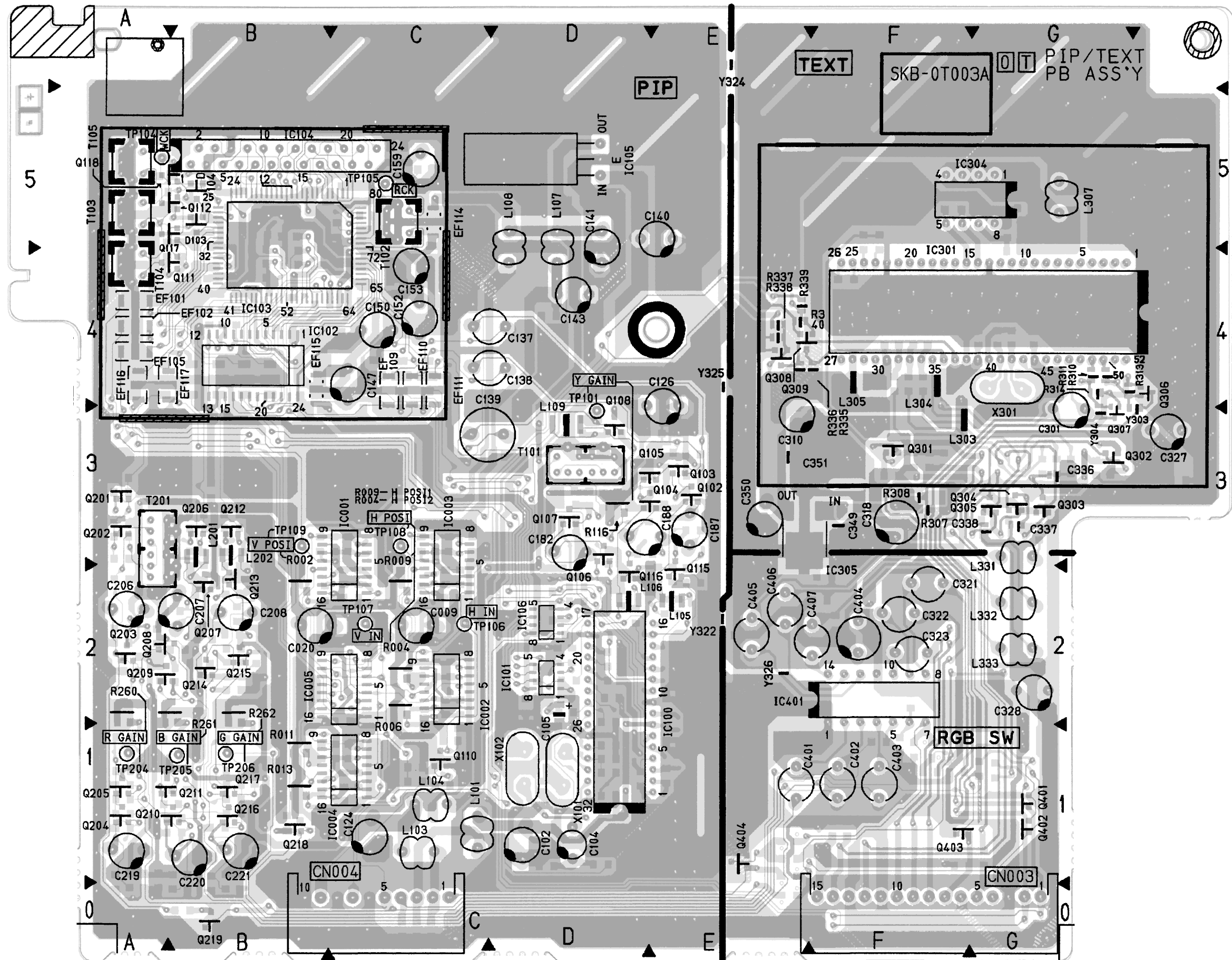

AUDIO PWB PATTERN [SODER SIDE]

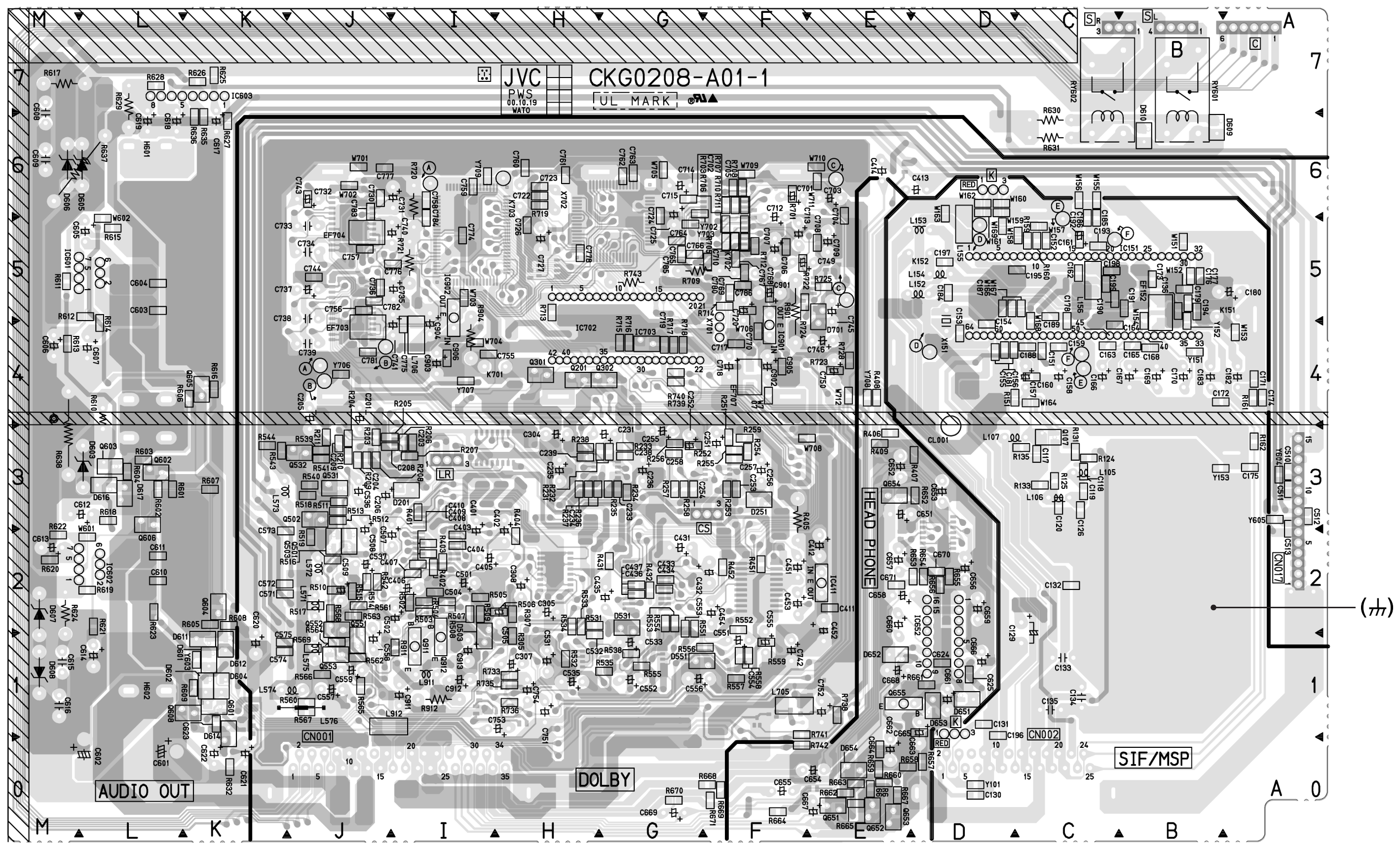

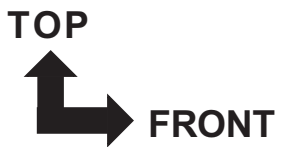

AUDIO PWB PATTERN [PARTS SIDE]

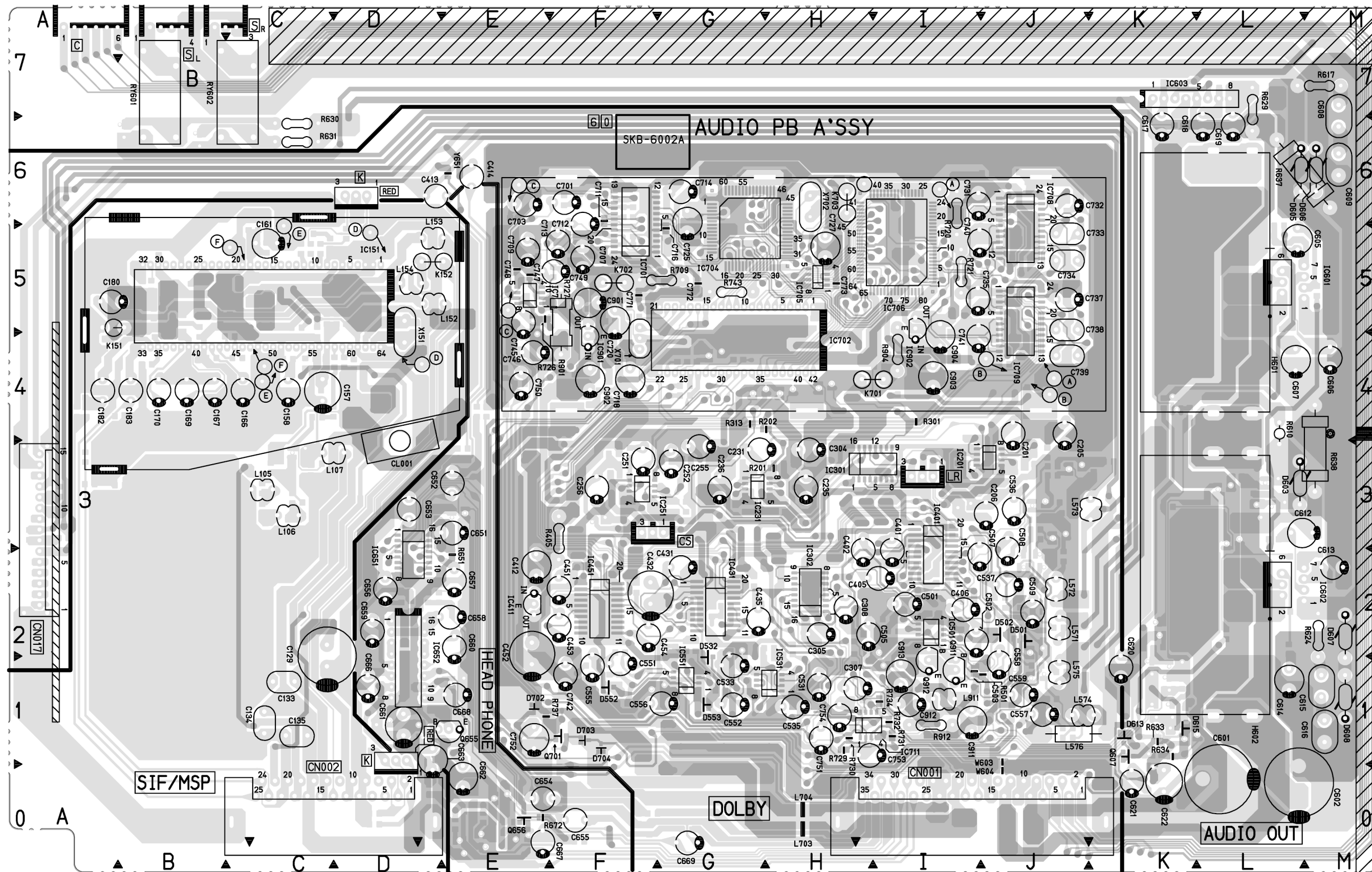

POWER PWB PATTERN

← FRONT

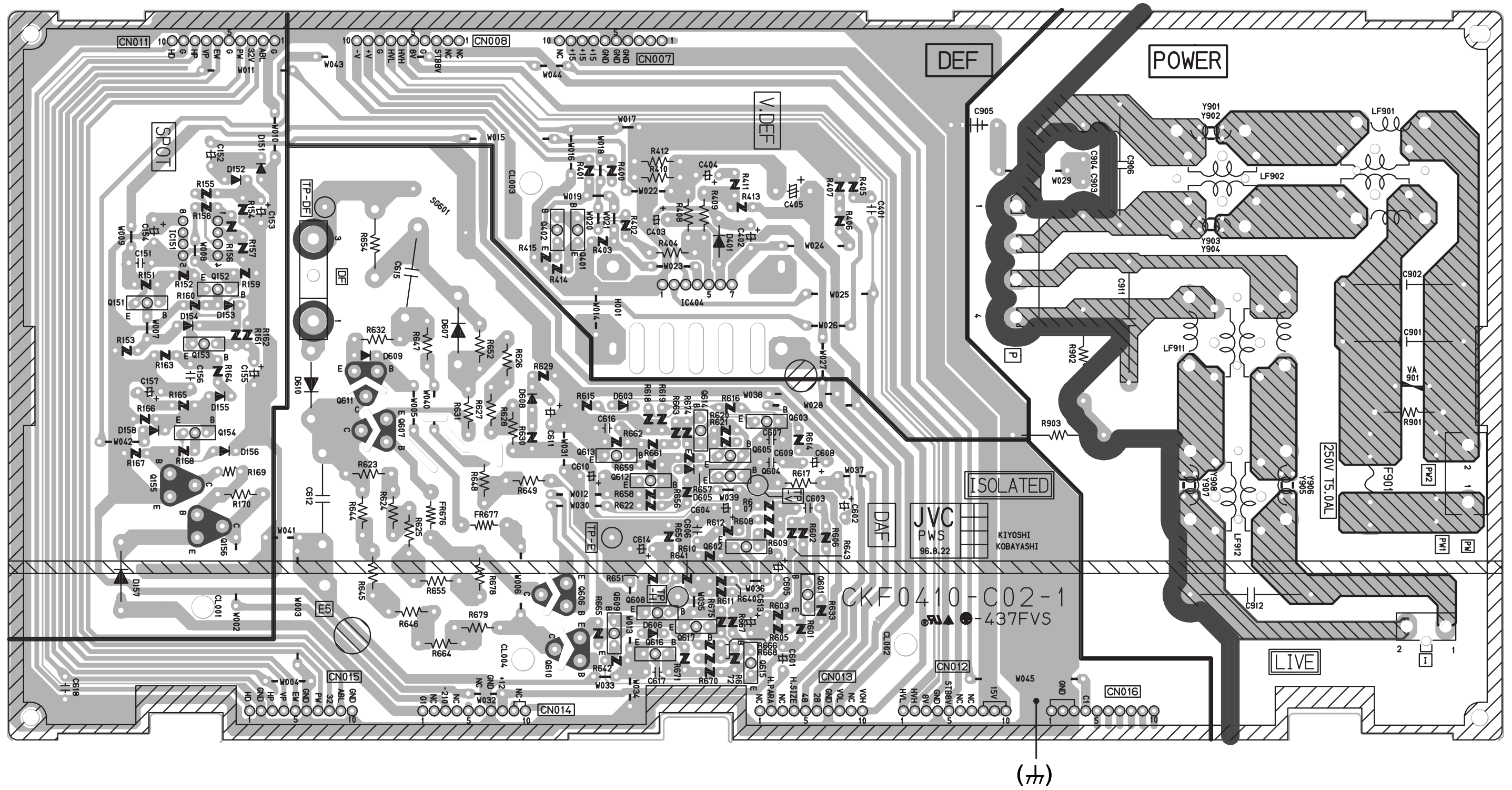

DEF. PWB PATTERN

FRONT

(F)

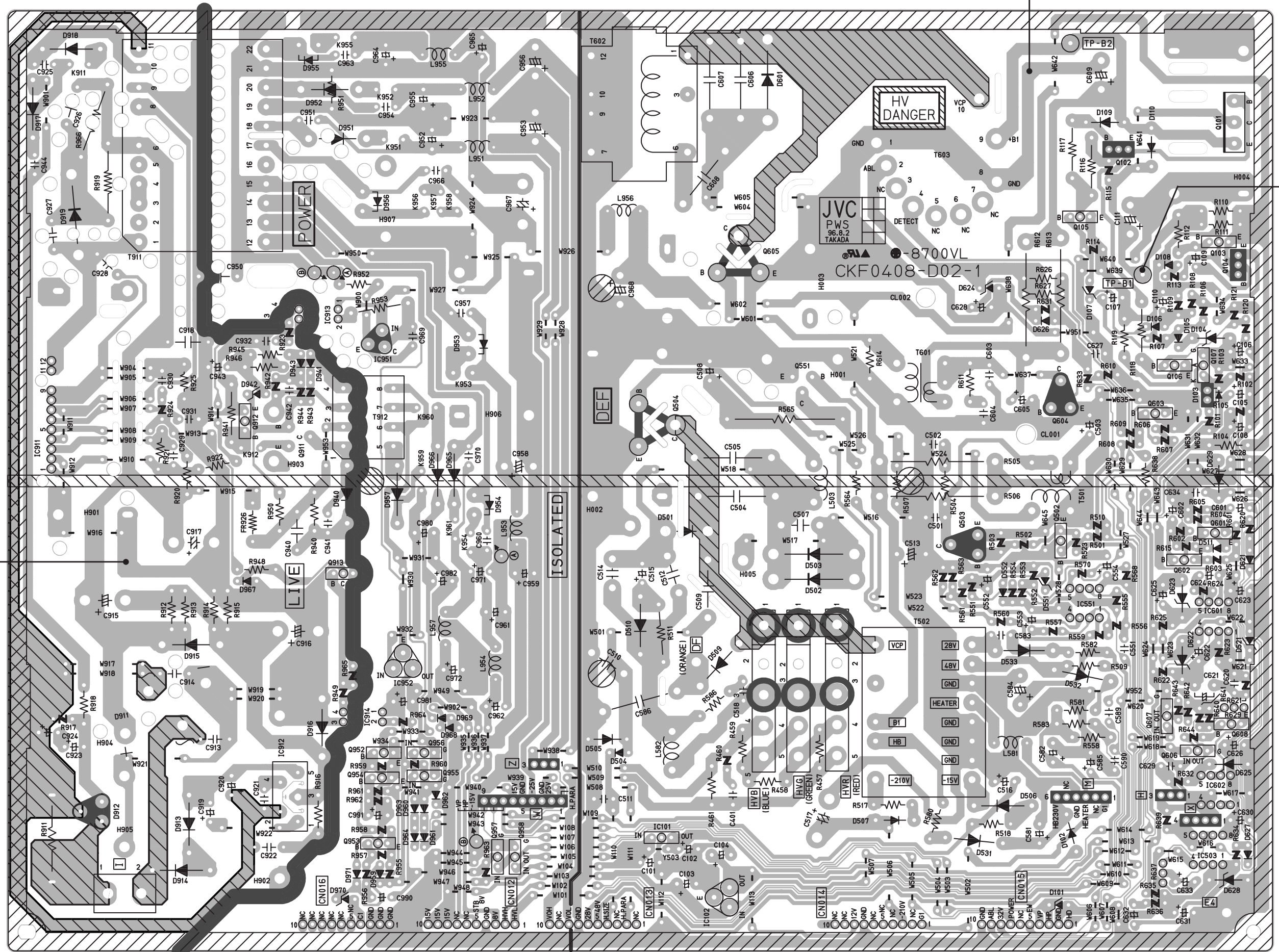

TP-91 (B1)

(F)

CONVERGENCE PWB PATTERN

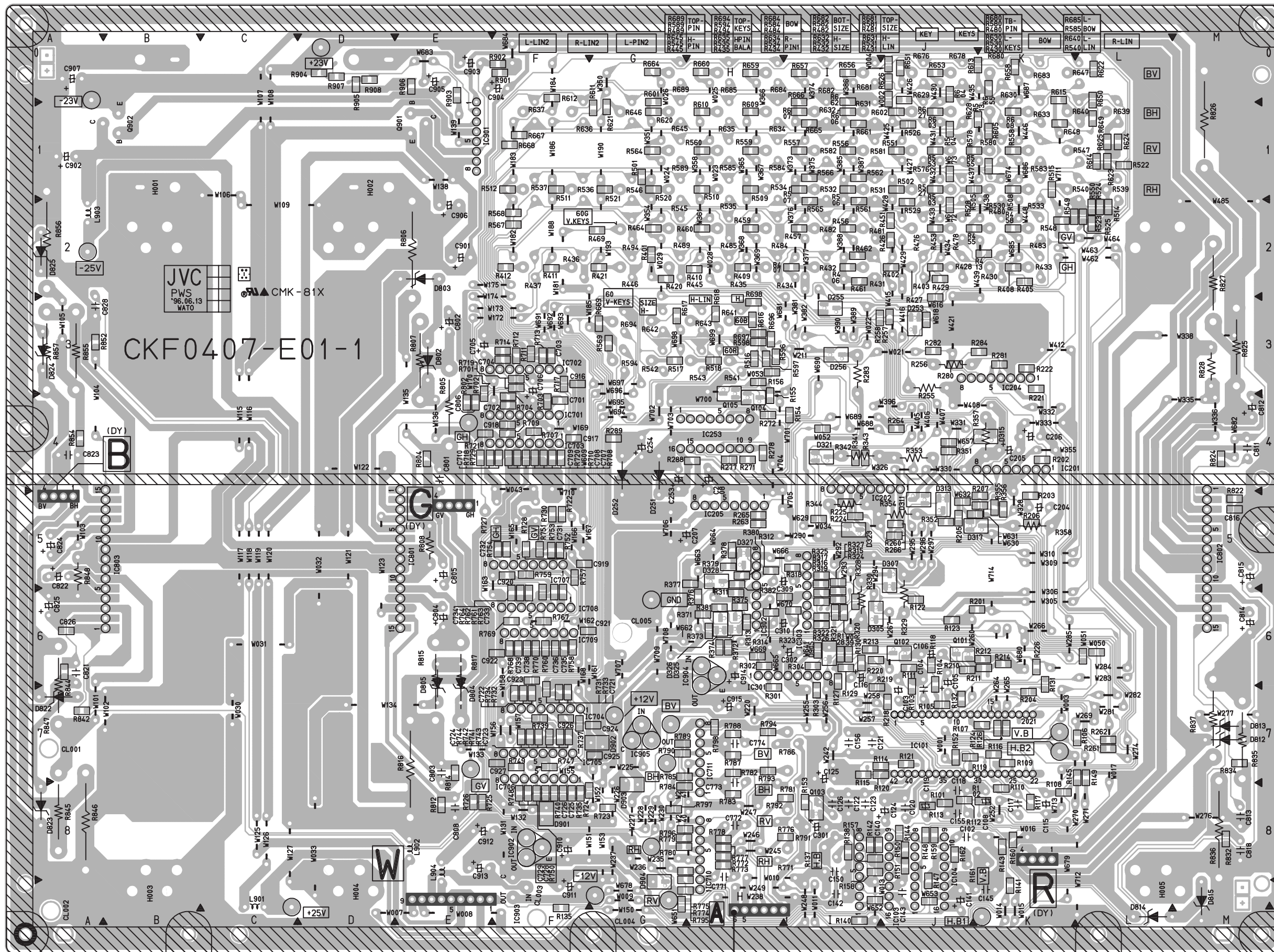

↑
TOP
(FRONT)



AV TERMINAL PWB PATTERN

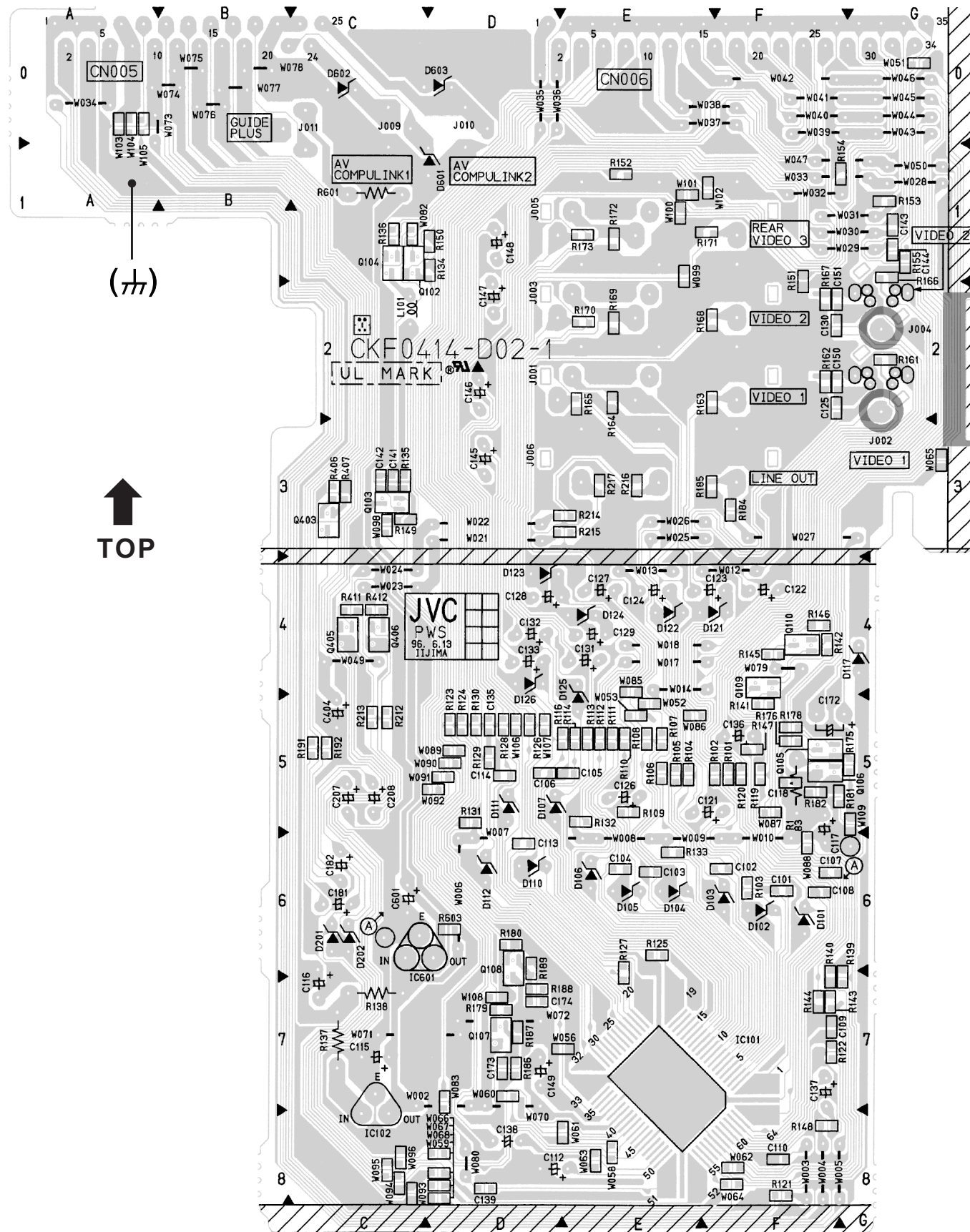

TOP

REMO-CON PWB PATTERN

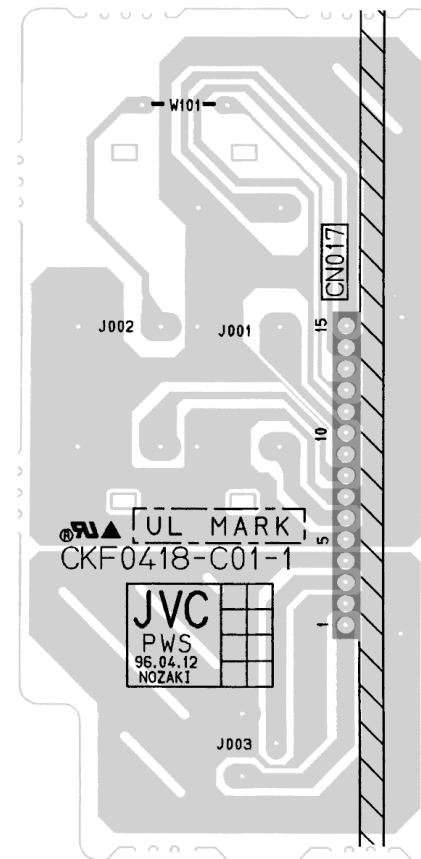

TOP

PIN JACK PWB PATTERN

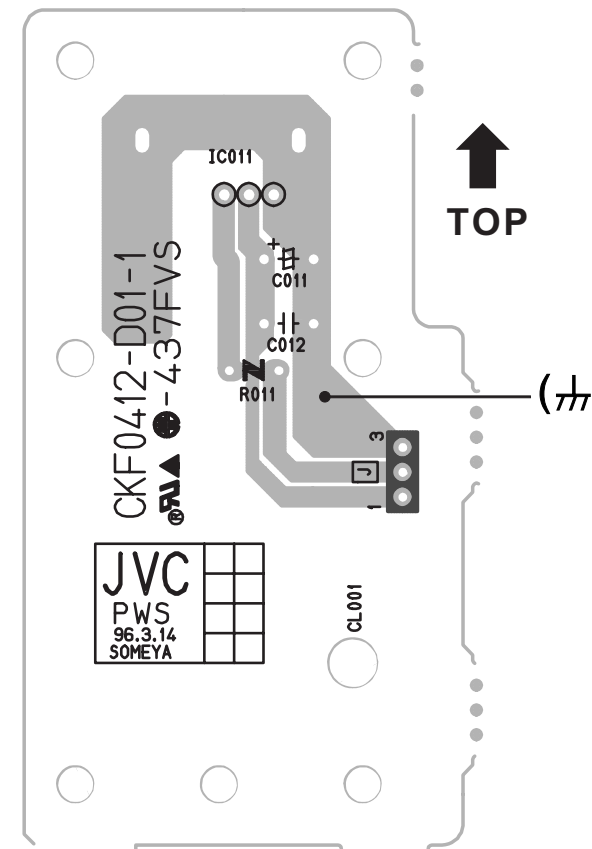

TOP

FRONT CONTROL PWB PATTERN

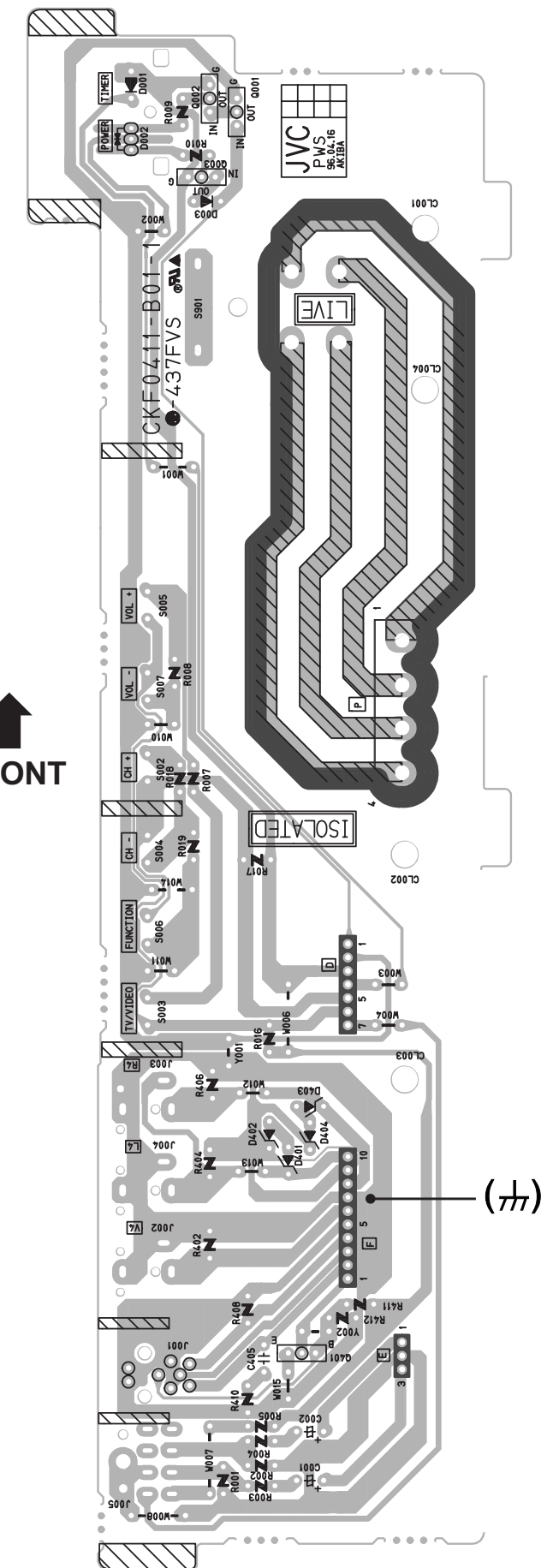

G CRT SOCKET PWB PATTERN

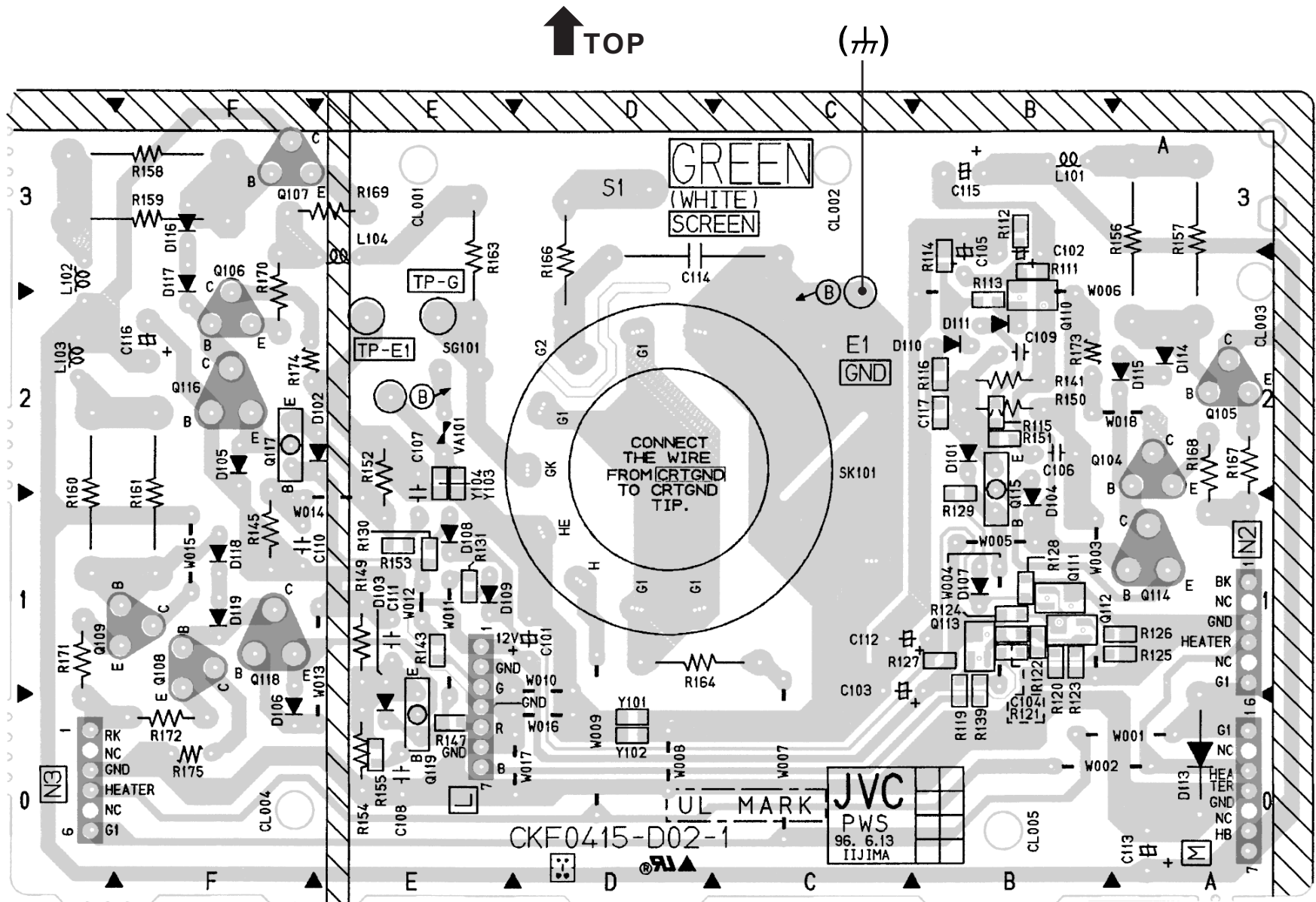

B CRT SOCKET PWB PATTERN

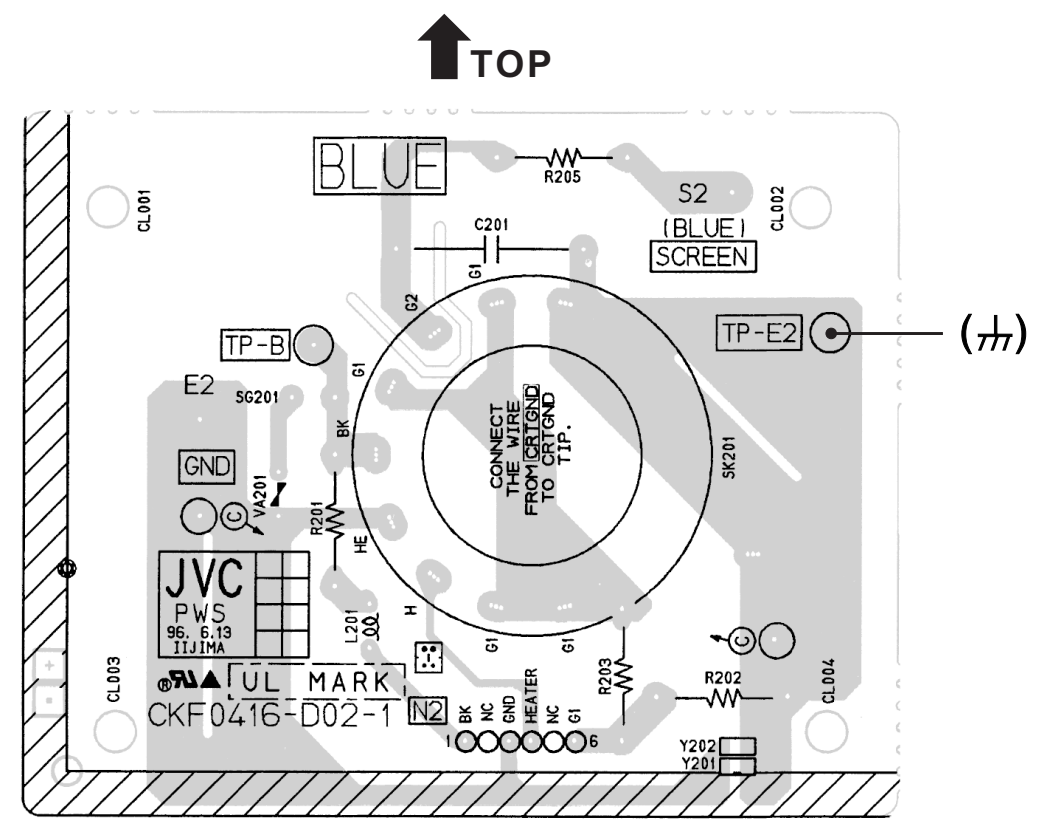

R CRT SOCKET PWB PATTERN

